

# Mito

## technical specification



.mdd

**.mdd has a leading position among manufacturers of office furniture with many awards that prove quality and continuously increase demand for its products.**

The realities of today's market require constant quality improvement at all levels of modern organization. This applies in particular to customer service, marketing, quality of products and also to quality of processes within the company.

Partnership relations among employees and with business partners form a base of economic growth and success of the company.

Constant investments in innovative machinery park, optimization of management systems and an expansion of production halls allow to minimize the lead times for the product of the highest quality.

**More than twenty years of experience in office furniture industry come with reference from a long list of companies and institutions to show their appreciation for an efficient and comprehensive service.**

**.mdd is highly aware of the environment.**

Being located in the forest region with lake by its side, .mdd takes the nature seriously and invests constantly in a modern and energy-efficient solutions to preserve the local life. Company puts emphasis on waste segregation and recycling. .mdd has been awarded for the exceptional care and involvement in waste disposal. All materials used are environmentally friendly and enjoy a high 95 % rate of being recycled.



## General informations:

### Warranty:

.mdd products - **5 years.**

Electrical components and fabric - **2 years.**

### Certificate - MFC:



### Compliant with standards:

PN-EN 527-2:2017-02

PN-EN 14073-2:2006

### Boards density:

12 mm - 690 - 750 kg/m<sup>3</sup>

18 mm - 650 - 690 kg/m<sup>3</sup>

28 mm - 610 - 630 kg/m<sup>3</sup>

36 mm - 610 - 630 kg/m<sup>3</sup>

### Assembly:

product delivered in separate elements

### Packing:

**desks, desks with managerial storage,**

**electric desks, pedestals, storages:**

cardboard;

### tables:

cardboard, perforated plastic mesh wrap

Desks

- 1. **Worktop** - MFC 38 mm, ABS edge
- 2. **Top** - MFC 38 mm, ABS edge
- 3. **Base** - MFC 38 mm, ABS edge
- 4. **Body** - MFC 18 mm, ABS edge
- 5. **Sliding front** - MFC 18 mm, ABS edge
- 6. **Front** - MFC 18 mm, ABS edge
- 7. **Central lock** - foldable key
- 8. **Modesty panel** - MFC 18 mm, ABS edge
- 9. **HPL base** - high gloss - 38 mm
- 10. **Mediaport S91E** - OPTION WITH EXTRA CHARGE - 2x 230V, 2x RJ45

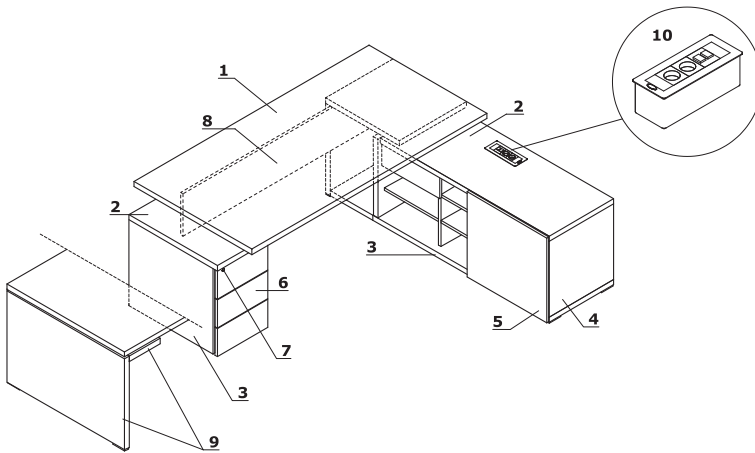

Managerial storages

- 1. **Top** - MFC 38 mm, ABS edge
- 2. **Front** - MFC 18 mm, ABS edge
- 3. **Interior** - MFC 18 mm
- 4. **Drawer** - MFC 18 mm, ABS edge, patent lock - possible to change location
- 5. **Side panels** - MFC 38 mm, ABS edge
- 6. **Mediaport S91E** - OPTION WITH EXTRA CHARGE - 2x 230V, 2x RJ45
- 7. **Cable grommets** - Ø80 mm

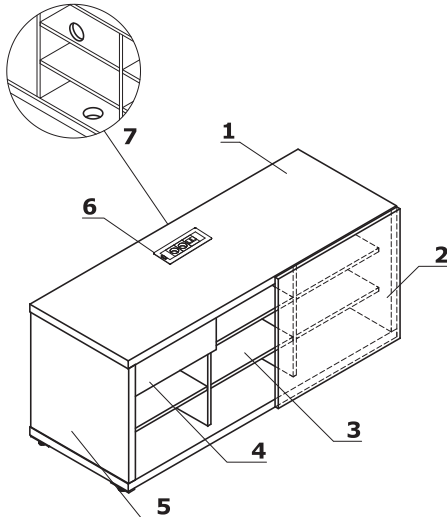

www.mdd.eu

Configuration examples

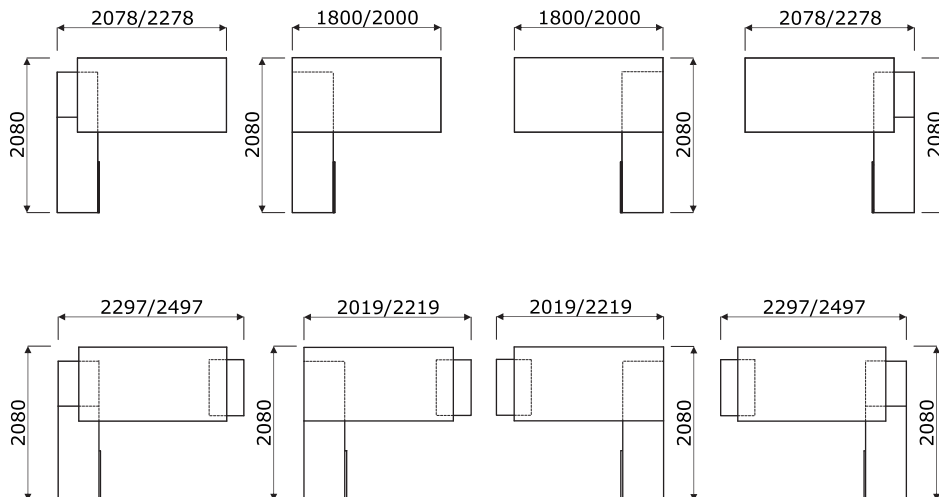

<b>Mito</b>	Date of preparation 23.12.2021	The data contained in this document is valid in the day of its preparation. Change of the product, as long as it does not affect the basic features of it, does not require consistent updates of the document.	page 3/24 technical specification
-------------	-----------------------------------	---	--------------------------------------

## Deks with electric height adjustment and managerial storage

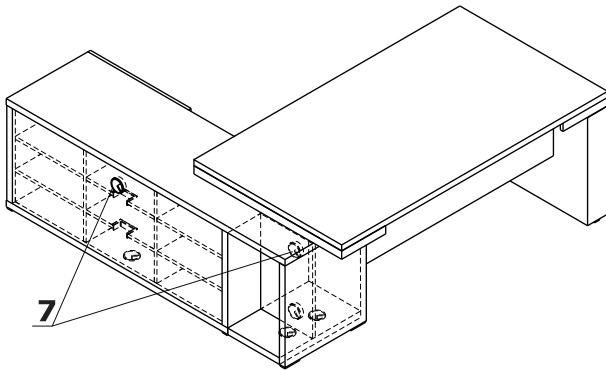
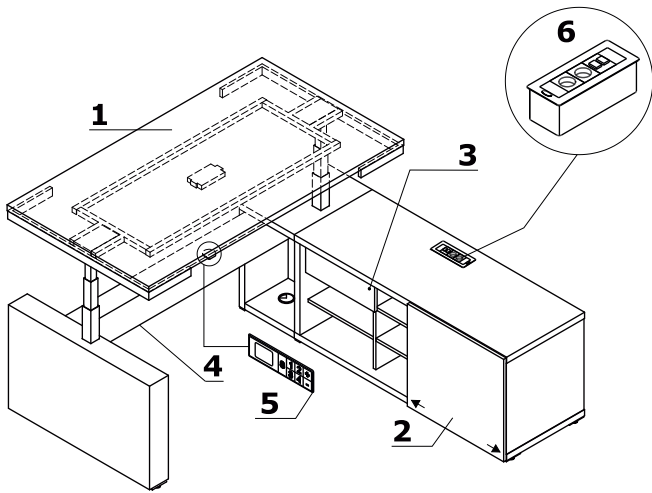

1. **Worktop** - MFC 38 mm, ABS edge
2. **Sliding front** - MFC 18 mm, ABS edge
3. **Drawer** - MFC 18 mm, ABS edge, possible to change location
4. **Electric height adjustable frame** - powder coated steel, load 100 kg, telescopic leg 60/60, 50/50, 40/40 mm
5. **Control panel:**
  - A - up and down keypad with memory; the ability to change the sensitivity of the anti-collision system within 3 levels: Low, Medium, High
  - B - OPTION FOR AN ADDITIONAL COST to panel A - bluetooth module - control via MDD Desk BT application (downloadable from Google Play or App Store). The app has a time interval function that informs the user about the need of changing body position (from sitting to standing or standing to sitting)
6. **Mediaport S91E** - OPTION WITH EXTRA CHARGE - 2x 230V, 2x RJ45
7. **Cable grommets**

### Frame technical specification:

- **Height adjustment** - 40 mm/sec Super Soft Start - Stop
- **Drive** - 2 synchronised motors with microprocessor, work control sensor
- **ISP** - Intelligent System Protection
- **Standards** - EN 527-2
- **EU Directives** - 206/95EC, UI508 1999, UL 1004 R7 06, WE DC 2004/108WE
- **Power supply** - 230V, 300W, power consumption on Standby - 0.3W

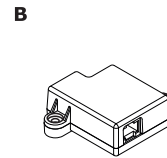
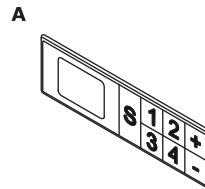

## Filing drawers storages

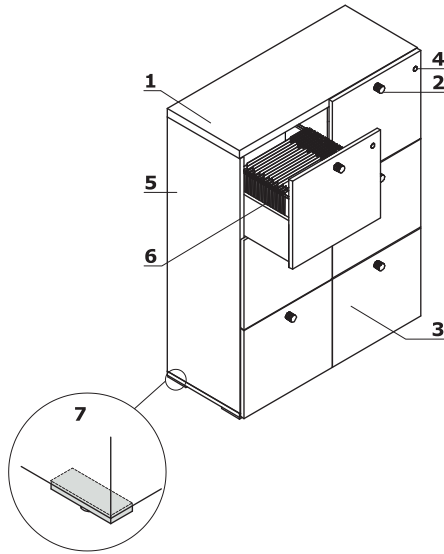

1. Top - MFC 38 mm, ABS edge
2. Aluminum handle
3. Front - HPL - high gloss
4. Central lock - foldable key
5. Side panels - MFC 18 mm, ABS edge
6. Suspension files drawer - MFC 18 mm, ball runners, max load 45kg, 100% extraction
7. Leveling - 5 mm range

## Sliding door storages

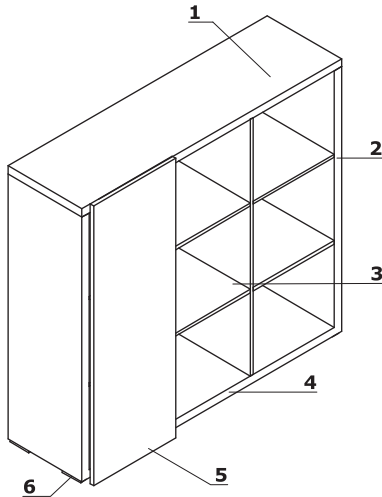

1. Top - MFC 38 mm, ABS edge
2. Side panels - MFC 38 mm, ABS edge
3. Interior - MFC 18 mm
4. Base - MFC 38 mm, ABS edge
5. Sliding front - MFC 18 mm, ABS edge
6. Leveling - 5 mm range

Sliding front storages MIT7 / MIT18

## Storages

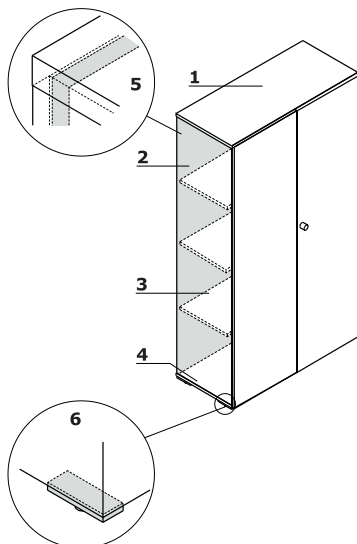

1. Top - MFC 18 mm, ABS edge
2. Side panels - MFC 18 mm, ABS edge
3. Shelf - MFC 18 mm, protection against accidental falling-out, ABS edge
4. Base - MFC 18 mm, ABS edge
5. Back MFC - 18 mm, ABS edges
6. Leveling - 5 mm range
7. Espagnolette lock in doorknob

## Disc base meeting tables

1. **Worktop** - MFC 38 mm, ABS edge
2. **Column** - powder coated steel
3. **Disc** - stainless steel INOX, powder coated

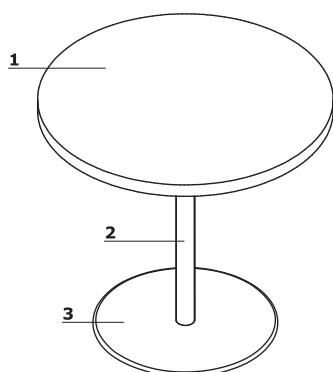

## MFC base meeting tables

1. **Blat** - płyta melaminowana 38 mm, obrzeża ABS
2. **Podstawa** - HPL - połysk 38 mm
3. **Łączyna** - płyta melaminowana 18 mm, obrzeża ABS
4. **Regulator poziomu** - regulacja w zakresie 5 mm
5. **Mediaport S91E** - OPCJA Z DOPŁATĄ - 2x 230V, 2x RJ45
6. **Mediaport S92E** - OPCJA Z DOPŁATĄ - 4x 230V, 4x RJ45

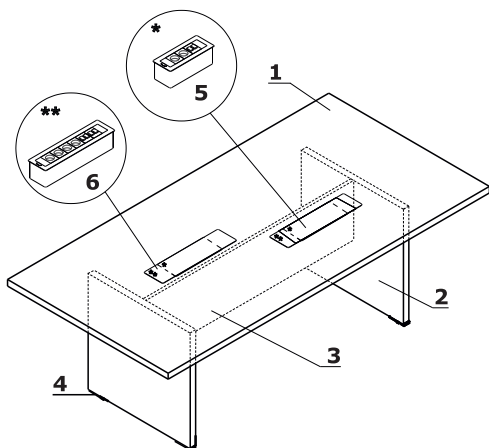

www.mdm.eu

## Mobile pedestal without handles (MIT120, MIT130)

1. **Top** - MFC 18 mm, ABS edge
2. **Body** - MFC 18 mm, ABS edge
3. **MFC drawer** - ball runners, max load 25kg, 100% extraction; Anti-tilt mechanism, soft closing
4. **Castors** - Ø50 mm, two with brakes
5. **Front** - MFC 18 mm, ABS edge
6. **Central lock** - foldable key
7. **Pencil tray** - plastic, colour: black
8. **Optional cushion SKP13** - for pedstal, max load 120 kg, ordered separately

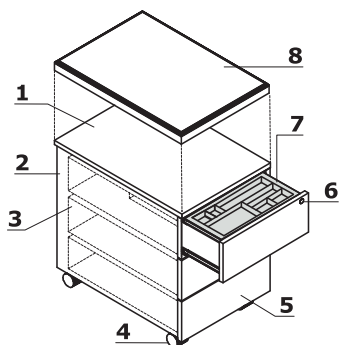

ATTENTION - sitting on the pedestal possible only after mounting the cushion (SKP13); the pedestal with cushion is intended for sitting only - moving the pedestal while sitting may result in damaging the castors.

Mito	Date of preparation 23.12.2021	The data contained in this document is valid in the day of its preparation. Change of the product, as long as it does not affect the basic features of it, does not require consistent updates of the document.	page 6/24 technical specification
------	-----------------------------------	---	--------------------------------------

**Mobile pedestal without handles (SLD12HT, SLD13HT)**

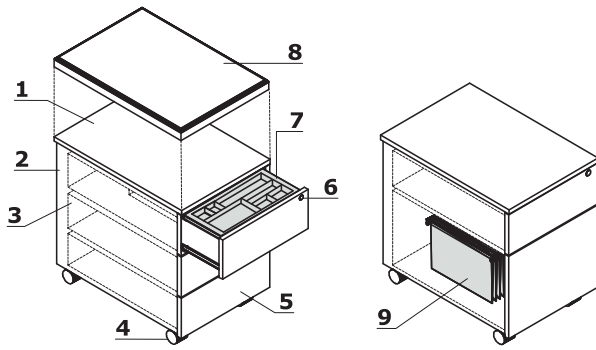

1. **Top** - MFC 18 mm, coated with HPL high gloss
2. **Body** - MFC 18 mm, ABS edge
3. **Metal drawer** - roll runners, max load 25 kg, 80% extraction, anti-tilt mechanism; OPTION WITH EXTRA CHARGE - ball runners, soft-closing system
4. **Castors** - Ø50 mm, two with brakes
5. **Front** - MFC 18 mm, coated with HPL high gloss, ABS edge
6. **Central lock** - foldable key
7. **Pencil tray** - plastic, colour: black
8. **Optional cushion SKP13** - for pedstal, max load 120 kg, ordered separately
9. **Suspension files drawer** - ball runners, max load 30 kg, 100% extraction, A4 folders can be situated parallelly and perpendicularly to the front

ATTENTION - sitting on the pedestal possible only after mounting the cushion (SKP13); the pedestal with cushion is intended for sitting only - moving the pedestal while sitting may result in damaging the castors.

Possible mediaport location

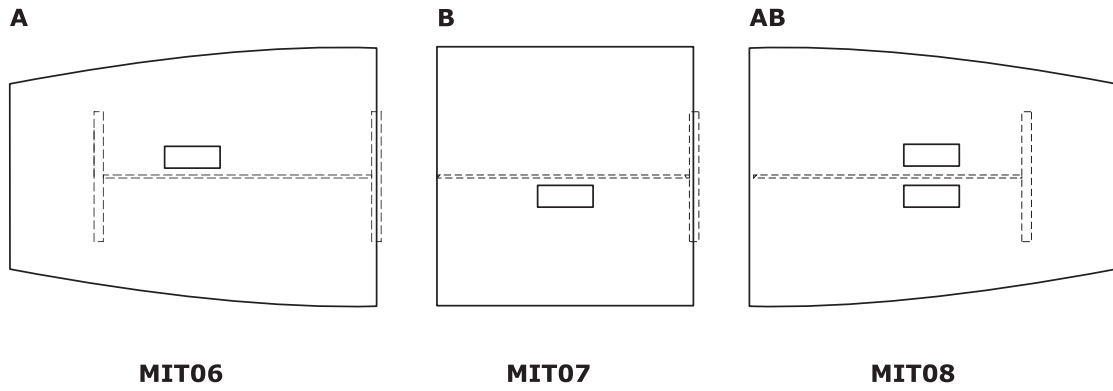

**Desks \***

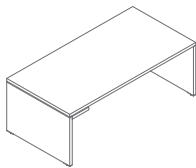

**MIT3**  
2000 / 1000 / 740  
111.95 kg

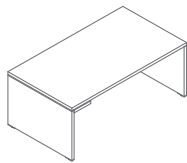

**MIT4**  
1800 / 1000 / 740  
108.85 kg

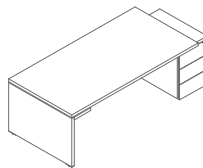

**MIT3KD**  
2219 / 1000 / 740  
162 kg

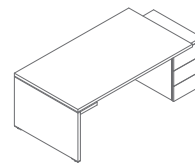

**MIT4KD**  
2019 / 1000 / 740  
153.55 kg

**Desk extension \***

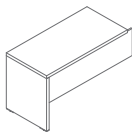

**MIT12**  
1200 / 600 / 740  
37.4 kg

**Desks with managerial storage \***

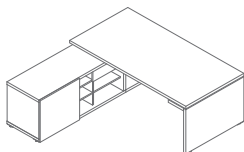

**MIT1**  
2000-2278 / 2080 / 740  
233.95 kg

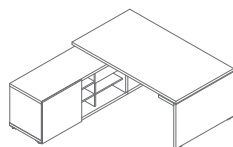

**MIT2**  
1800-2078 / 2080 / 740  
230.85 kg

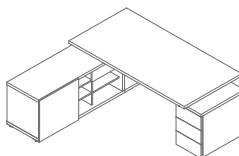

**MIT1KD**  
2219-2497 / 2080 / 740  
273.5 kg

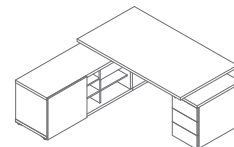

**MIT2KD**  
2019-2297 / 2080 / 740  
265.05 kg

**Desks with electric height adjustment and managerial storage \***

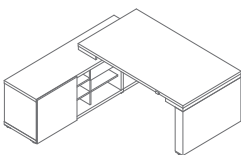

**MIT1RL**  
2190 / 2080 / 1300-760  
354.05 kg

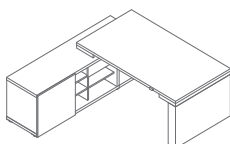

**MIT2RL**  
1990 / 2080 / 1300-760  
342.15 kg

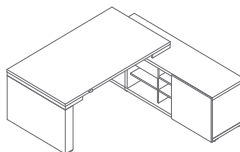

**MIT1RP**  
2190 / 2080 / 1300-760  
360.2 kg

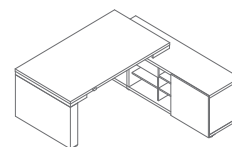

**MIT2RP**  
1990 / 2080 / 1300-760  
348.3 kg

\* dimensions expressed in millimeters: width x depth x height

Mobile pedestal without handles \*

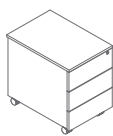

**MIT130**  
428 / 600 / 586  
35 kg



**SLD13HT**  
416 / 600 / 587  
23 kg

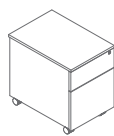

**MIT120**  
428 / 600 / 586  
32 kg

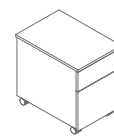

**SLD12HT**  
416 / 600 / 587  
23 kg

Meeting tables \*



**MIT10**  
800 / 800 / 740  
34.2 kg



**MIT17**  
1200 / 1200 / 740  
59.4 kg

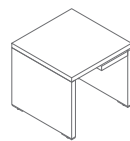

**MIT23**  
600 / 600 / 550  
31.9 kg

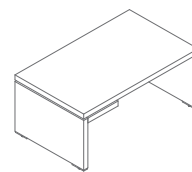

**MIT9**  
1000 / 600 / 450  
37.2 kg

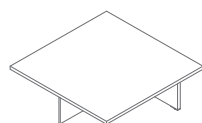

**MIT07**  
1400 / 1400 / 740  
118 kg

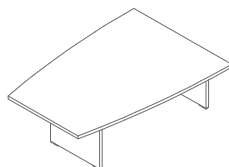

**MIT06**  
2000 / 1000-1400 / 740  
154.15 kg

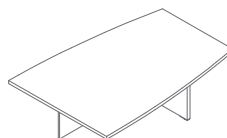

**MIT08**  
2000 / 1000-1400 / 740  
142.5 kg

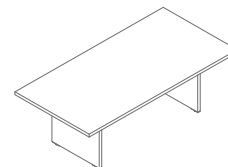

**MIT11**  
2200 / 1100 / 740  
102.15 kg

Meeting tables - pre-defined configurations \*

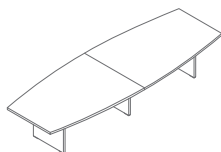

**MIT24**  
4000 / 1400-1000 / 740  
181.15 kg

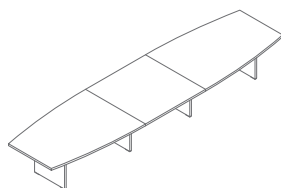

**MIT25**  
5400 / 1400-1000 / 740  
243.7 kg

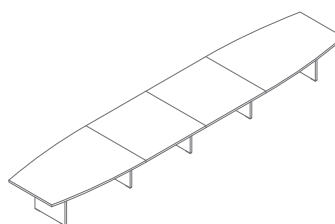

**MIT26**  
6800 / 1400-1000 / 740  
306.25 kg

\* dimensions expressed in millimeters: width x depth x height

Storages with HPL front \*

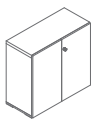

**MIT21**  
916 / 418 / 879  
53.9 kg

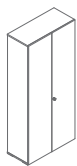

**MIT19**  
916 / 418 / 2077  
113.75 kg

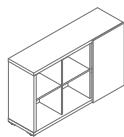

**MIT18**  
1400 / 422 / 879  
82.05 kg

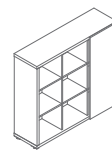

**MIT7**  
1400 / 422 / 1280  
108.55 kg

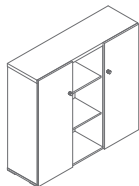

**MIT20**  
1363 / 418 / 1280  
99.85 kg

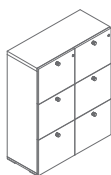

**MIT22**  
980 / 418 / 1280  
110.25 kg

Storages \*

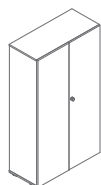

**MIT8**  
916 / 418 / 1661  
85.55 kg

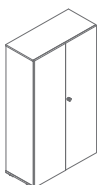

**MIT15**  
916 / 418 / 1661  
89 kg

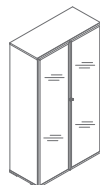

**MIT16**  
916 / 418 / 1661  
90.3 kg

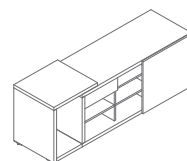

**MIT5**  
1887 / 572 / 690  
141.5 kg

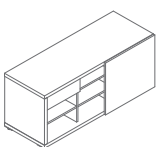

**MIT6**  
1500 / 572 / 652  
115.5 kg

\* dimensions expressed in millimeters: width x depth x height

**Desks - with matte finish elements \***

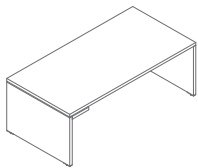

**MIT3L**  
2000 / 1000 / 740  
108 kg

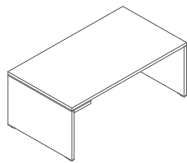

**MIT4L**  
1800 / 1000 / 740  
105.55 kg

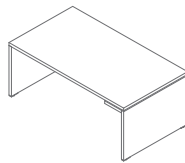

**MIT3P**  
2000 / 1000 / 740  
108.65 kg

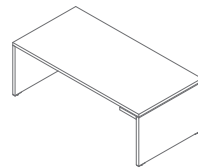

**MIT4P**  
1800 / 1000 / 740  
105.55 kg

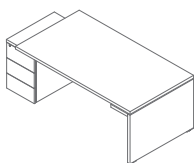

**MIT3KDL**  
2219 / 1000 / 740  
159.6 kg

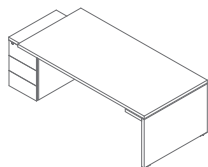

**MIT4KDL**  
2019 / 1000 / 740  
151.15 kg

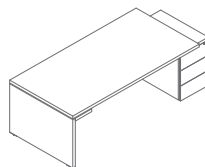

**MIT3KDP**  
2219 / 1000 / 740  
159.6 kg

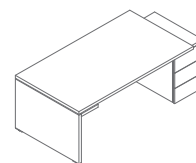

**MIT4KDP**  
2019 / 1000 / 740  
151.15 kg

**Desk extension - with matte finish elements \***

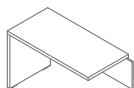

**MIT12L**  
1200 / 600 / 740  
32.4 kg

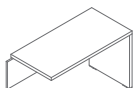

**MIT12P**  
1200 / 600 / 740  
32.45 kg

**Desks with managerial storage - with matte finish elements \***

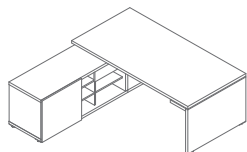

**MIT1L**  
2000-2278 / 2080 / 740  
230.05 kg

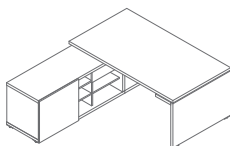

**MIT2L**  
1800-2078 / 2080 / 740  
226.95 kg

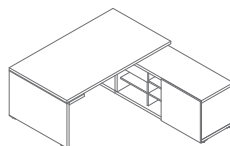

**MIT1P**  
2000-2278 / 2080 / 740  
230.05 kg

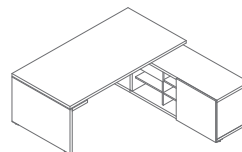

**MIT2P**  
1800-2078 / 2080 / 740  
226.95 kg

\* dimensions expressed in millimeters: width x depth x height

**Desks with managerial storage - with matte finish elements \***

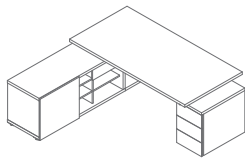

**MIT1KDL**  
2219-2497 / 2080 / 740  
272 kg

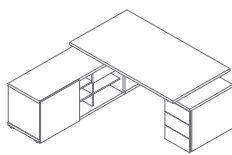

**MIT2KDL**  
2019-2297 / 2080 / 740  
263.55 kg

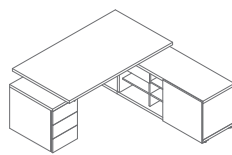

**MIT1KDP**  
2219-2497 / 2080 / 740  
272 kg

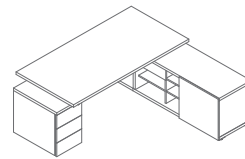

**MIT2KDP**  
2019-2297 / 2080 / 740  
263.55 kg

**Desks with electric height adjustment and managerial storage - with matte finish elements \***

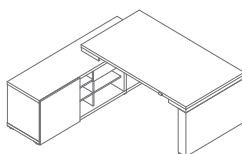

**MIT27RL**  
2190 / 2080 / 1300-760  
299.9 kg

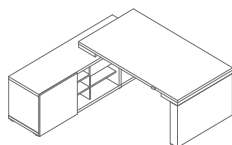

**MIT28RL**  
1990 / 2080 / 1300-760  
292.8 kg

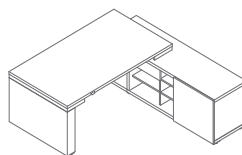

**MIT27RP**  
2190 / 2080 / 1300-760  
299.9 kg

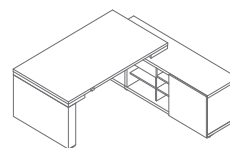

**MIT28RP**  
1990 / 2080 / 1300-760  
292.8 kg

**Mobile pedestal without handles - with matte finish elements \***

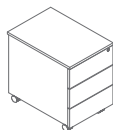

**SLD13HTM**  
416 / 600 / 587  
23 kg

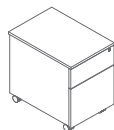

**SLD12HTM**  
416 / 600 / 587  
23 kg

**Meeting tables - with matte finish elements \***

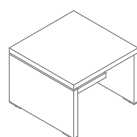

**MIT29**  
600 / 600 / 550  
30.75 kg

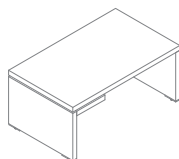

**MIT30**  
1000 / 600 / 450  
36.9 kg

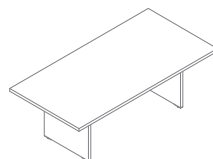

**MIT45**  
2200 / 1100 / 740  
102.15 kg

\* dimensions expressed in millimeters: width x depth x height

Storages - with matte finish elements \*

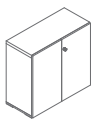

**MIT31**  
916 / 418 / 879  
98 kg

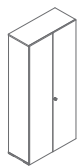

**MIT32**  
916 / 418 / 2077  
107.25 kg

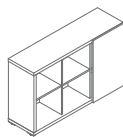

**MIT33**  
1400 / 422 / 879  
146.05 kg

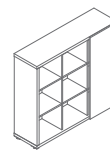

**MIT34**  
1400 / 422 / 1280  
108.55 kg

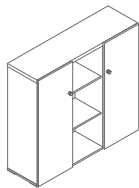

**MIT38**  
1363 / 418 / 1280  
99.85 kg

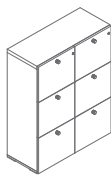

**MIT35**  
980 / 418 / 1280  
110.25 kg

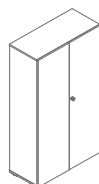

**MIT39**  
916 / 418 / 1661  
85.55 kg

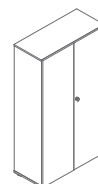

**MIT40**  
916 / 418 / 1661  
89 kg

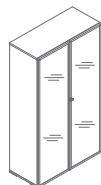

**MIT41**  
916 / 418 / 1661  
90.3 kg

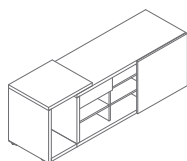

**MIT36**  
1887 / 572 / 690  
138.4 kg

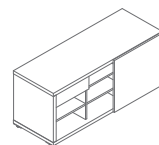

**MIT37**  
1500 / 572 / 652  
115.5 kg

\* dimensions expressed in millimeters: width x depth x height

**Desks - Antifinger worktop \***

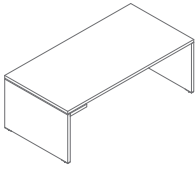

**MITF3L**  
2000 / 1000 / 740  
97.95 kg

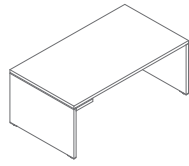

**MITF4L**  
1800 / 1000 / 740  
95.7 kg

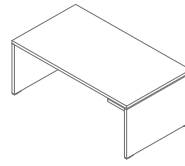

**MITF3P**  
2000 / 1000 / 740  
114.95 kg

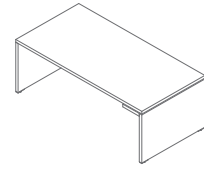

**MIT4FP**  
1800 / 1000 / 740  
95.7 kg

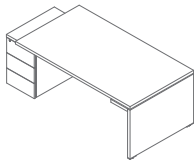

**MITF3KDL**  
2219 / 1000 / 740  
159.6148.2

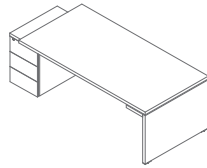

**MITF4KDL**  
2019 / 1000 / 740  
143.2 kg

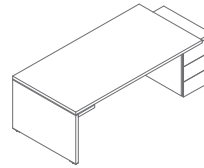

**MITF3KDP**  
2219 / 1000 / 740  
148.2 kg

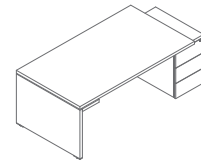

**MITF4KDP**  
2019 / 1000 / 740  
143.2 kg

**Desk extension - Antifinger worktop \***

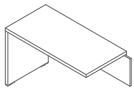

**MITF12L**  
1200 / 600 / 740  
32.4 kg

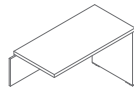

**MITF12P**  
1200 / 600 / 740  
32.4 kg

**Desks with managerial storage - Antifinger worktop \***

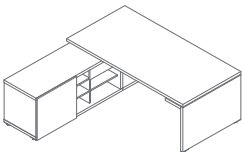

**MITF1L**  
2000-2278 / 2080 / 740  
239.7 kg

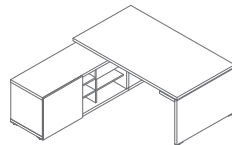

**MITF2L**  
1800-2078 / 2080 / 740  
237.4 kg

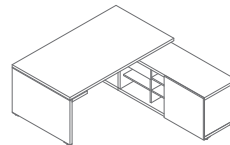

**MITF1P**  
2000-2278 / 2080 / 740  
239.7 kg

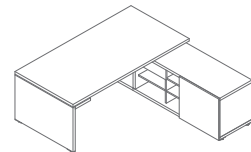

**MITF2P**  
1800-2078 / 2080 / 740  
237.4 kg

\* dimensions expressed in millimeters: width x depth x height

## Desks with managerial storage - Antifinger worktop \*

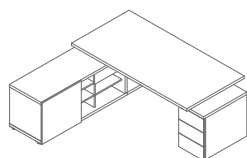

**MITF1KDL**  
2219-2497 / 2080 / 740  
280.9 kg

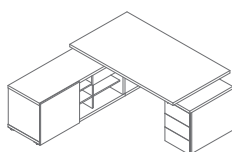

**MITF2KDL**  
2019-2297 / 2080 / 740  
275.9 kg

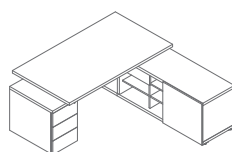

**MITF1KDP**  
2219-2497 / 2080 / 740  
280.9 kg

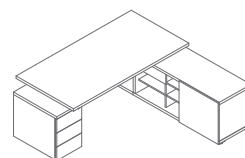

**MITF2KDP**  
2019-2297 / 2080 / 740  
280.9 kg

## Desks with electric height adjustment and managerial storage - Antifinger worktop \*

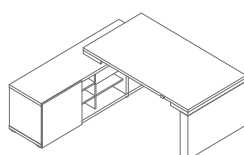

**MITF27RL**  
2190 / 2080 / 1300-760  
432.6 kg

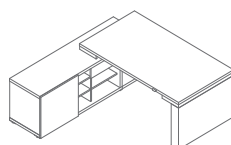

**MITF28RL**  
1990 / 2080 / 1300-760  
426.6 kg

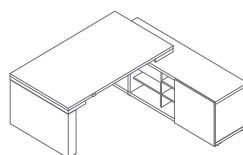

**MITF27RP**  
2190 / 2080 / 1300-760  
432.6 kg

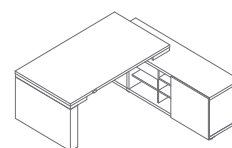

**MITF28RP**  
1990 / 2080 / 1300-760  
432.6 kg

## Meeting tables - Antifinger worktop \*

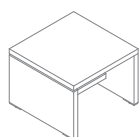

**MITF29**  
600 / 600 / 550  
52.4 kg

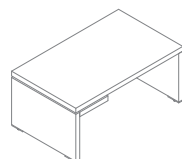

**MITF30**  
1000 / 600 / 450  
58 kg

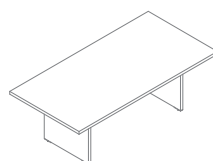

**MITF45**  
2200 / 1100 / 740  
102.15 kg

## Accessories \*



**S100**  
416 / 600 / 50  
0 kg



**SKP13**  
400 / 600 / 52  
3 kg

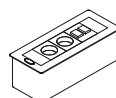

**S91E**  
267 / 110 / 93  
1 kg

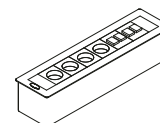

**S92E**  
426 / 110 / 93  
1 kg

\* dimensions expressed in millimeters: width x depth x height

<b>Mito</b>	Date of preparation 23.12.2021	The data contained in this document is valid in the day of its preparation. Change of the product, as long as it does not affect the basic features of it, does not require consistent updates of the document.	page 16/24
			products

**Desks, MIT11**

**Top**



172 Amber oak



173 Robinia

**Base HPL**



73 White high gloss



101 Black high gloss



155 Anthracite high gloss

**Tables - disc base**

**Top**



172 Amber oak

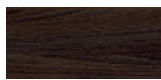

173 Robinia

**Supporting leg**



M009 Aluminum semi-matt RAL9006



M015 White semi-matt RAL9010



M115 Black semi-matt RAL9005



M154 Anthracite semi-matt RAL7043

**MIT5 - extension**



73 White high gloss



101 Black high gloss



155 Anthracite high gloss

**Storages with HPL front**

**Top, base, body**



172 Amber oak



173 Robinia

**Front**



73 White high gloss



101 Black high gloss



155 Anthracite high gloss

**Mobile pedestal without handles (SLD12HT, SLD13HT)**

**Top, front**



73 White high gloss



101 Black high gloss



155 Anthracite high gloss

Mobile pedestal without handles (SLD12HT, SLD13HT)

Body



67 White pastel



08 Black

Mobile pedestal without handles (MIT120, MIT130)

Top, front, body



172 Amber oak



173 Robinia

Desk with managerial storage

Top



172 Amber oak



Grommet



Grey



173 Robinia



Black

Desks - with matte finish elements, MIT29, MIT30, MIT45



172 Amber oak



173 Robinia

Base



186 Black matt  
RAL9005



188 White matt  
RAL9010

MIT36



186 Black matt  
RAL9005



188 White matt  
RAL9010

Storages - with matte finish elements

Top, base, body



172 Amber oak



173 Robinia



186 Black matt  
RAL9005

Front



186 Black matt  
RAL9005



188 White matt  
RAL9010

Mobile pedestal without handles



186 Black matt  
RAL9005



188 White matt  
RAL9010

Desks - Antifinger worktop, MITF29, MITF30, MITF45

Top



183 Fenix black  
matt RAL9005

Leg



172 Amber oak

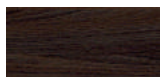

173 Robinia



186 Black matt  
RAL9005

SKP13

Fabric Nemo

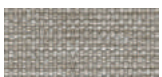

NE-1 Beige



NE-2 Yellow

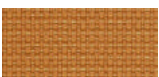

NE-3 Orange



NE-5 Red



NE-9 Green



NE-10 Grey

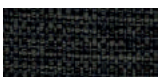

NE-14 Graphite



NE-15 Navy blue



NE-16 Black



NE-17 Blue

Technical data:

<b>Material</b>	polyester 100%
<b>Fabric weight</b>	366g/m2
<b>Abrasion resistance rubs</b>	PN_EN ISO 12947 - 2:2 100,000
<b>Pilling resistance</b>	scale 1-8, max. 8, PN-EN ISO 105 - B02 (3-4)
<b>Colour fastness to light</b>	scale 1-5, max. 5, PN-EN 1021 - 2,
<b>Colour fastness to rubbing</b>	PN-EN 1021 - 1
	skale 1-5, max. 5, EN ISO 105x12
	(wet/dry) 4-5

### Fabric Runner – second price group



**Technical data:**

**Material** 80% polyester, 20% post-consumer recycled polyester

**Fabric weight** 510 g/lm (16.45 oz./lin.yd.)

**Abrasion resistance rubs** BS EN ISO 12947-2  
70,000 Martindale cycles

**Pilling resistance** scale 1-5, max 5, EN ISO 12945-2 (4-5)

**Colour fastness to light** scale 1-8, max 8, EN ISO 105-B02 (5-7)

**Colour fastness to rubbing** scale 1-5, max 5, EN ISO 105x12  
(wet/dry) 4-5

**Acoustic test sound absorption** ISO 354

**Flammability** BS EN 1021-2 Match,  
CA TB 117-2013, BS EN 1021-1  
(cigarette) Class Uno UNI 9175 Class 2,  
EMME

### Fabric Medley – second price group



**Technical data:**

**Material** polyester 100%

**Fabric weight** 510 g/lm (16.45 oz./lin.yd.)

**Abrasion resistance rubs** BS EN ISO 12947-2, 75,000 cykli Martindale

**Pilling resistance** scale 1-5, max. 5, EN ISO 12945-2 (4)

**Colour fastness to light** scale 1-8, max. 8, EN ISO 105-B02 (5-7)

**Colour fastness to rubbing** scale 1-5, max. 5, EN ISO 105x12  
(wet/dry) (4-5/4-5)

**Acoustic test sound absorption** ISO 354

**Flammability** BS EN 1021-1 (cigarette)  
BS 476 Part 7, Class 2  
Class Uno UNI 9174 - UNI 8457  
CA TB 117-2013  
ASTM E 84 Class I

### Fabric Atlantic – second price group \*



**Technical data:**

**Material** polyester 100%

**Fabric weight** 530 g/lm (17.09 oz./lin.yd.)

**Abrasion resistance rubs** BS EN ISO 12947-2, 110,000 Martindale cycles

**Pilling resistance** scale 1-5, max. 5, EN ISO 12945-2 (4-5)

**Colour fastness to light** scale 1-8, max. 8, EN ISO 105-B02 (5-7)

**Colour fastness to rubbing** scale 1-5, max. 5, EN ISO 105x12  
(wet/dry)

**Flammability** CA TB 117-2013  
ASTM E 84 Class I  
BS EN 1021-2 (match)  
BS EN 1021-1 (cigarette)

\* There is a possibility of ordering the product in full colour spectrum of Atlantic range, as per Gabriel's pattern book, within 8 weeks

### Fabric Vita – second price group



**Technical data:**

**Material** Surface: 98,5% PVC, 1,5% PU  
Substrate: 50% poliester, 50% Cotton

**Fabric weight** 850g/m2 ± 10% (1190G/lin. m ± 10%)

**Abrasion resistance rubs** BS EN ISO 5470-2, 100,000 Martindale cycles

**Colour fastness to light** 6 (ISO 105 - B02)

**Colour fastness to rubbing** wet: 4, dry: 4 (ISO 105 - X12)

**Flammability** BS EN 1021 - (cigarette)  
BS EN 1021 - 2 (match)  
BS 5852 - (Ignition Source 5)  
BS 7176 - (Medium Hazard)

**Flexes** BS EN ISO 7854 - Method B,  
400.000 Flexing cycles

**Anti-microbial / Anti-fungal** AATCC 147

### Fabric Charles – second price group



**Technical data:**

**Material** 100% polyester

**Fabric weight** 433g/m2

**Abrasion resistance rubs** 90,000 Martindale cycles (EN ISO 12947-2)

**Pilling resistance** EN ISO 12945-2, 5

**Light fastness** EN ISO 105-B02, 5

**Rubbing fastness** dry: 4-5, wet: 4-5, EN ISO 105x12

**Flammability** EN 1021, 1

### Fabric Mica - second price group

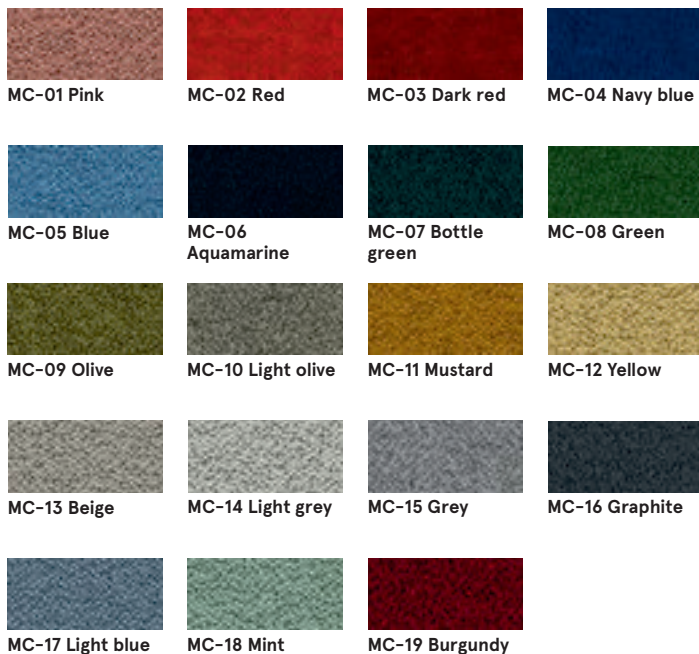

**Technical data:**

**Material** post-consumer recycled polyester 97%, polyester 3%

**Fabric weight** 305 g/lm

**Abrasion resistance rubs** 60,000 rubs martindale (EN ISO 12947-2)

**Pilling resistance** scale 1-5, max. 5 - EN ISO 12945-2, 4-5

**Light fastness** scale 1-8, max. 8 - EN ISO 105-B02, 5-8

**Rubbing fastness** dry: 4-5, wet: 4-5, scale 1-5, max. 5 - EN ISO 105x12

**Flammability** CA TB 117-2013  
ASTM E 84 Class I  
BS EN 1021-1 Cigarette  
BS EN 1021-2 Match  
BS 476 Part 7 class I

### Fabric Go Check - second price group

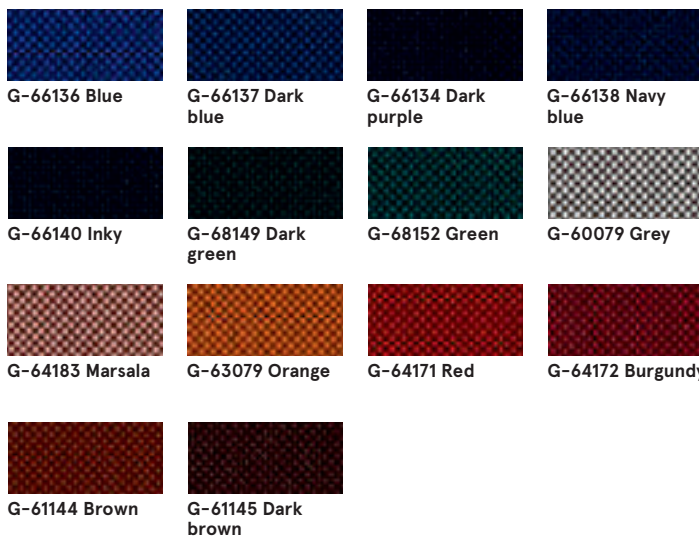

**Technical data:**

**Material** 100% Trevira CS

**Fabric weight** 435g/lm

**Abrasion resistance rubs** 80,000 rubs martindale (EN ISO 12947-2)

**Pilling resistance** scale 1-5, max. 5 - EN ISO 12945-2, 5

**Light fastness** scale 1-8, max. 8 - EN ISO 105-B02, 5-8

**Rubbing fastness** dry: 4-5, wet: 4-5, scale 1-5, max. 5 - EN ISO 105x12

**Flammability** BS EN 1021 1&2 Cigarette and Match  
BS EN 1021-1 Cigarette  
BS 5852 Crib 5  
BS 7176 Medium hazard  
DIN 4102 - B1  
NFP 92-503/504/505 M1  
ÖNORM A3800-B1-B3825-Q1 UK  
Class Uno UNI 9175 Class 1 I EMME  
FAR/JAR 25.853 (a) (i) (ii)  
CA TB 117-2013  
DIN EN 13501-1 B-s1,d0  
AM 18 - NF D 60-013-(only for fabric)

### Fabric Xtreme - third price group



**Technical data:**

**Material** 100% Trevira Clame (CS)  
100% Recykling (YS)  
Flame Retardant polyester.  
Non metallic dyestuffs.

**Fabric weight** 310 g/m2 ±5% (435g/lin.m ±5%)

**Abrasion resistance rubs** 60,000 Martindale cycles (CS)  
100,000 Martindale cycles (YS)

**Colour fastness to light** 6 (ISO 105 - B02)

**Colour fastness to rubbing** wet: 4, dry: 4 (ISO 105 - X12)

**Flammability** EN 1021 - 1 (cigarette),  
EN 1021 - 2 (match)  
BS 7176 Low Hazard,  
NF P92-507 M1, DIN 4102 B1,  
UNI 9175 Class 1 IM, UNI 8456,  
UNI 9174 & UNI 9177 Classe Uno,  
ÖNORM B 3825 & A 3800-1  
NF D 60-013

### Fabric Synergy - third price group



**Technical data:**

**Material** 95% Virgin Wool, 5% Poliamid

**Fabric weight** 400g/m2 ±5% (560 g/lin.m ±5%)

**Abrasion resistance rubs** Independently certified  
≥100,000 Martindale cycles

**Colour fastness to light** 5 (ISO 105 - B02)

**Colour fastness to rubbing** ISO 105 - X12 - wet: 4, dry: 4

**Flammability** EN 1021 - 1 (cigarette),  
EN 1021 - 2 (match),  
BS 7176 Low Hazard,  
UNI 9175 Classe 1 IM,  
ÖNORM B 3825 & A 3800-1

## Fabric Silvertex – third price group

There is a possibility of ordering the product in full colour spectrum of Silvertex range, as per Spradling’s pattern book, within 15 working days.

### Technical data:

<b>Material</b>	Topcoat: 100% Vinyl Backing: 100% Polyesterr Hi-Loft™
<b>Fabric weight</b>	685 gr/m2
<b>Abrasion resistance</b>	>300,000 cycles Martindale
<b>UV-resistance</b>	>= 7 (1000 hours, blue wool scale)
<b>Cold Crack resistance</b>	-23°C
<b>Flame retardancy</b>	NF P 92-503 / M2 EN 1021, Part 1&2 DIN 4102 B2 ÖNORM B 3825, Gruppe I - Schwerbrennbares Verhalten ÖNORM A 3800, Teil I, Qualmbildungsklasse QI - schwachqualmend IMO Res. MSC.307 (88) (2010 FTP Code) Annex I Part 8 (MED) Marine Equipment Directive in its current valid version UNI 91 75 (1987) / UNI 9175/FAI (1994) Classe I.IM (uno I EMME) UNE 23.727-90 IR /M2 EN 71-2: 2006+AI: 2007 Safety of Toys - Part 2: Flammability ECE R 11 8 (replaces Directive 95/28/EC) FMVSS 302 FAR 25/853
<b>Antimicrobial</b>	Antifungal Protection, Antibacterial Protection, Antimycotic Protection

## Fabric Atlas – fourth price group



### Technical data:

<b>Material</b>	90% new wool, 10% nylon
<b>Fabric weight</b>	286g/m2, 400g/lm
<b>Abrasion resistance rubs</b>	100,000 cykli Martindale, EN ISO 12947
<b>Colour fastness to light</b>	ISO 105 B02: 6-7
<b>Colour fastness to rubbing</b>	ISO 105-X12:2001, (wet/dry) 4-5/4-5
<b>Flammability</b>	BS EN 1021-2 Match, BS EN 1021-1 Cigarette, BS 5 5852 Crib 5, BS 5852 ignition source 3, BS 5852 Part 1, NF D 60 013, UNI 9175 11M, US Cal. Bull. 117-2013

## Fabric Field2 – fourth price group



### Technical data:

<b>Material</b>	100% Trevira CS
<b>Fabric weight</b>	321g/m2, 450g/lm
<b>Abrasion resistance rubs</b>	100,000 cykli Martindale, EN ISO 12947
<b>Colour fastness to light</b>	ISO 105 B02: 5-7
<b>Flammability</b>	BS EN 1021-2 Match, BS EN 1021-1 Cigarette, BS 5 5852 Crib 5, DIN 4102 B1 FAR 25.853, UNI 9177 classe 1, US Cal. Bull. 117-2013