











# RECEPTION DESKS

V.3 01.07.2017



	WAVE.....	002
	ARCTIC SUMMER.....	016
	ORGANIC.....	018
	LINEA.....	028
	ZIG-ZAG.....	040
	VALDE.....	050
	FORO.....	084
	ZEN.....	086
	OVO.....	088
	TERA.....	090

TECHNICAL SPECIFICATION

COLOURS

COUNTER TOP - GLASS



WHITE, LACOBEL



FRONT HPL



73 HIGH GLOSS WHITE



74 HIGH GLOSS ORANGE



80 HIGH GLOSS LIME



81 HIGH GLOSS BURGUNDY



BODY



67 WHITE PASTEL



SUPPORTING LEG WHERE WORKTOPS CONNECT NL41



M015 WHITE SEMI-MATTE

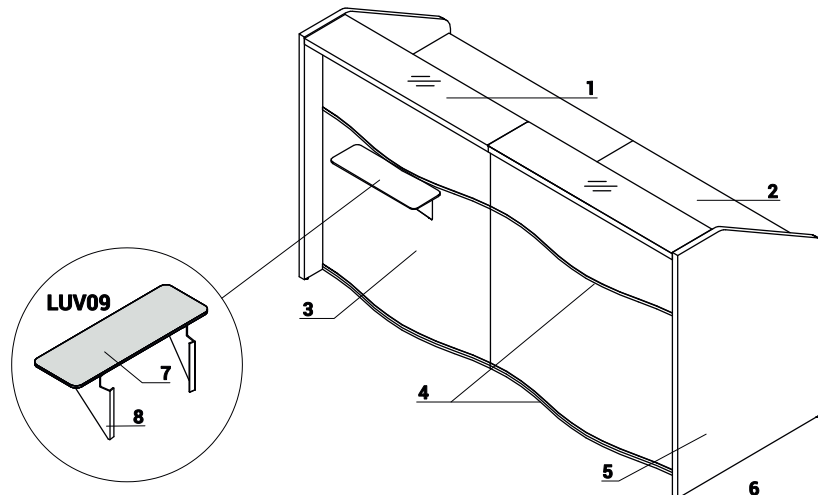

1. **Top** - MFC 36mm + Glass LACOBEL 4mm (40mm)
2. **Worktop** - MFC 28mm, PVC edge
3. **Front** - HPL - high gloss
4. **Decorative stripe** - PVC, colour M009 - aluminum semi-matte
5. **Low side panel** - MFC 28mm, PVC edge
6. **Leveling** - 10mm range
7. Shelf for reception counter, HPL mat 6mm
8. **Fixing element** - powder coated metal, color: M015 - metal white semi-matte

TECHNICAL SPECIFICATION

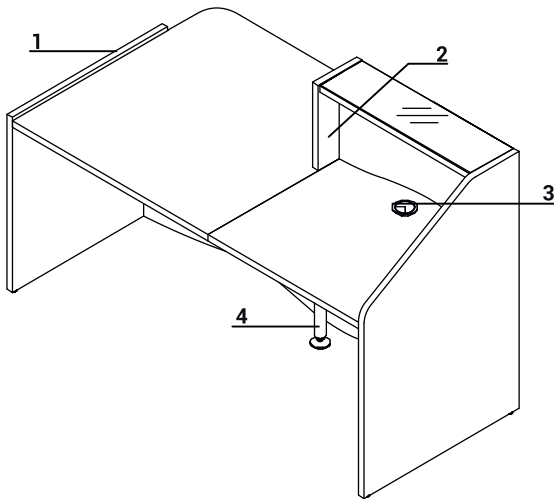

- 1. **Low side panel** - MFC 28mm, PVC edge
- 2. **Side panel linking low and high fronts** - MFC 28mm, PVC edge
- 3. **Cable grommets** - Ø80mm
- 4. **Supporting leg NL41**- required for connecting the tops

ATTENTION - Interior of the front in white

ENDING ELEMENTS APPLICATION

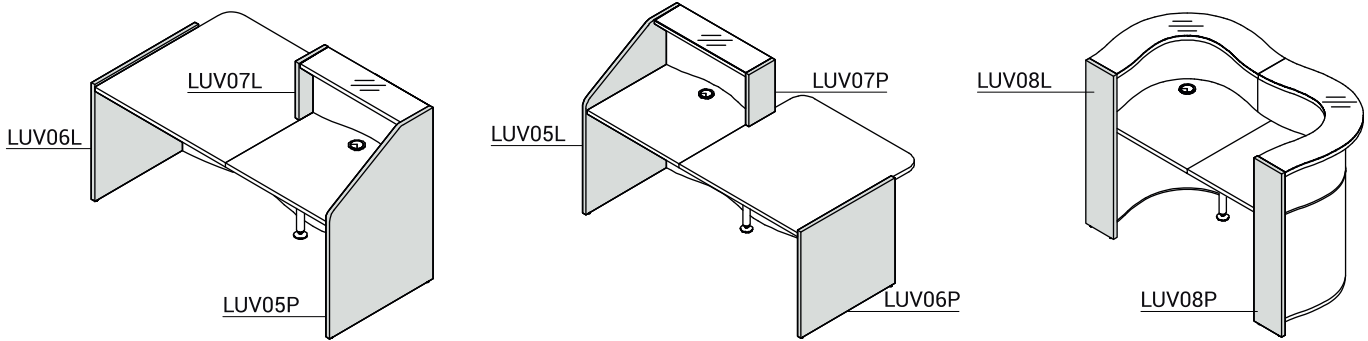

DIMENSIONS

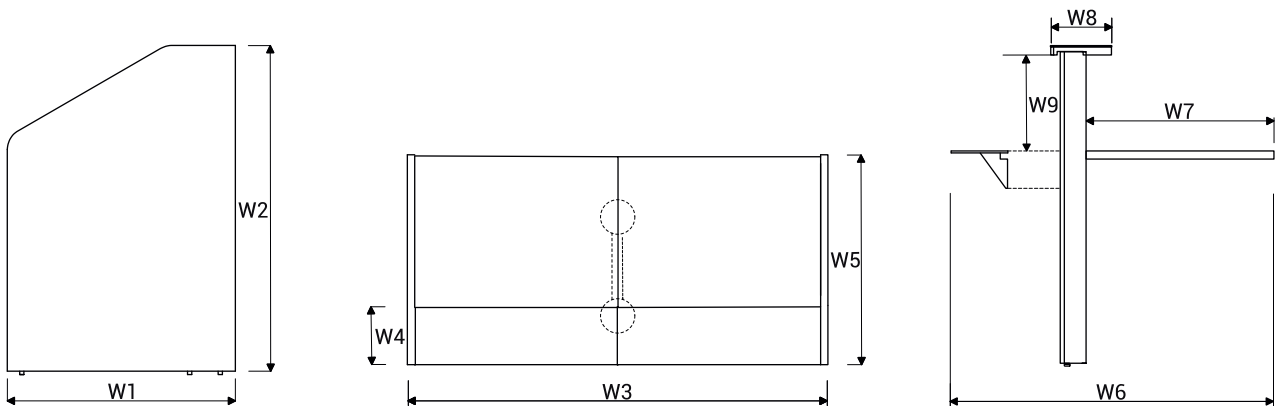

W1 - 770mm | W2 - 1103mm | W3 - 1556mm | W4 - 210mm | W5 - 770mm | W6 - 788mm | W7 - 650mm | W8 - 210mm | W9 - 330mm

RECEPTION DESKS SYSTEMS

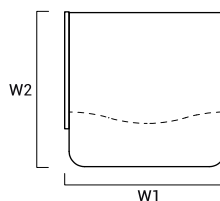
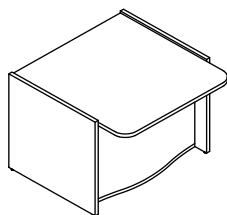

INDEX SYMBOL	DIMENSIONS [mm]					PRICE EUR				COMPONENTS
	W <sub>1</sub>	W <sub>2</sub>	D <sub>1</sub>	D <sub>2</sub>	H		kg	m <sup>3</sup>	pcs	
LUV10	1026	1119	-	-	755	820,-	50.0	0.167	4	LUV06L+LUV01+LUV06P
LUV101	826	1119	-	-	755	750,-	44.0	0.141	4	LUV06L+LUV011+LUV06P

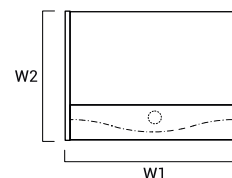
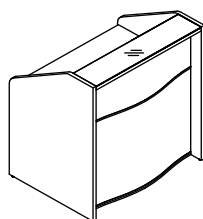

INDEX SYMBOL	DIMENSIONS [mm]					PRICE EUR				COMPONENTS
	W <sub>1</sub>	W <sub>2</sub>	D <sub>1</sub>	D <sub>2</sub>	H		kg	m <sup>3</sup>	pcs	
LUV11	806	770	-	-	1103	835,-	59.0	0.189	4	LUV05L+LUV02+LUV05P
LUV12	1026	770	-	-	1103	905,-	63.0	0.226	4	LUV05L+LUV03+LUV05P

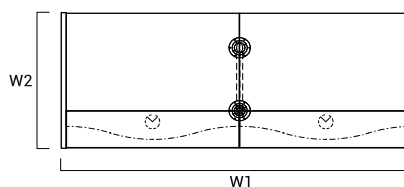
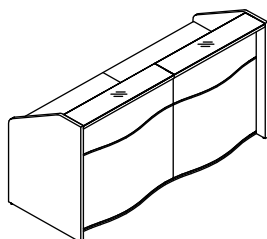

INDEX SYMBOL	DIMENSIONS [mm]					PRICE EUR				COMPONENTS
	W <sub>1</sub>	W <sub>2</sub>	D <sub>1</sub>	D <sub>2</sub>	H		kg	m <sup>3</sup>	pcs	
LUV13	1556	770	-	-	1103	1 520,-	90.0	0.380	7	LUV05L+2xLUV02+LUV05P+NL41
LUV14	1996	770	-	-	1103	1 660,-	98.0	0.453	7	LUV05L+2xLUV03+LUV05P+NL41

DESCRIPTION

- NET WEIGHT

VOLUME

NUMBER OF PACKAGES

RECEPTION DESKS SYSTEMS

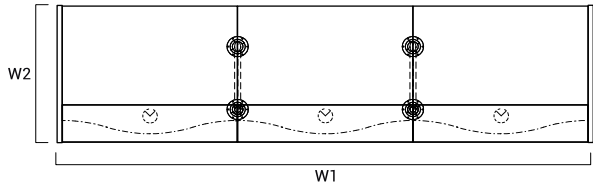
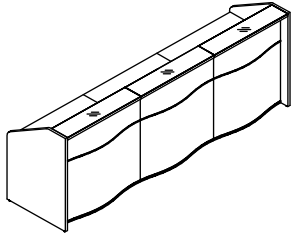

INDEX SYMBOL	DIMENSIONS [mm]					PRICE EUR				COMPONENTS
	W <sub>1</sub>	W <sub>2</sub>	D <sub>1</sub>	D <sub>2</sub>	H		kg	m <sup>3</sup>	pcs	
LUV15	2306	770	-	-	1103	2 205,-	121.0	0.570	10	LUV05L+3xLUV02+LUV05P +2xNL41
LUV16	2966	770	-	-	1103	2 415,-	133.0	0.681	10	LUV05L+3xLUV03+LUV05P +2xNL41

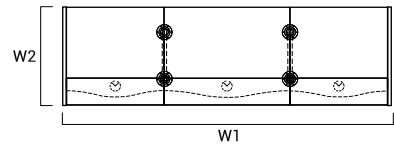
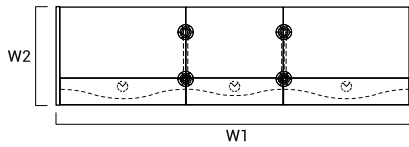
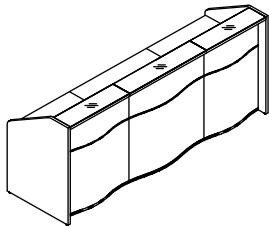

INDEX SYMBOL	DIMENSIONS [mm]					PRICE EUR				COMPONENTS
	W <sub>1</sub>	W <sub>2</sub>	D <sub>1</sub>	D <sub>2</sub>	H		kg	m <sup>3</sup>	pcs	
LUV17	2746	770	-	-	1103	2 275,-	129.0	0.644	10	LUV05L+2xLUV02+LUV03 +LUV05P+2xNL41
LUV18	2526	770	-	-	1103	2 345,-	125.0	0.607	10	LUV05L+2xLUV03+LUV02 +LUV05P+2xNL41

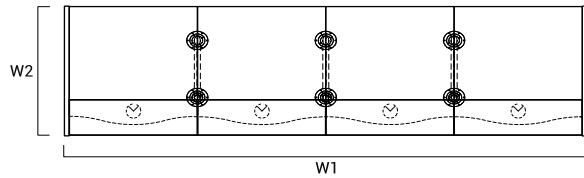
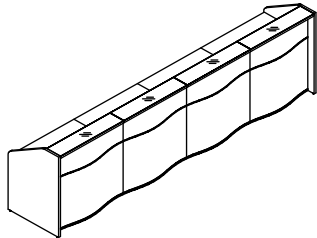

INDEX SYMBOL	DIMENSIONS [mm]					PRICE EUR				COMPONENTS
	W <sub>1</sub>	W <sub>2</sub>	D <sub>1</sub>	D <sub>2</sub>	H		kg	m <sup>3</sup>	pcs	
LUV19	3496	770	-	-	1103	2 890,-	152.0	0.761	13	LUV05L+4xLUV02+LUV05P +3xNL41
LUV20	3936	770	-	-	1103	3 170,-	168.0	0.909	13	LUV05L+4xLUV03+LUV05P +3xNL41

DESCRIPTION

- NET WEIGHT

VOLUME

NUMBER OF PACKAGES

RECEPTION DESKS SYSTEMS

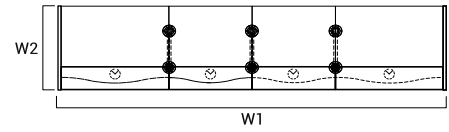
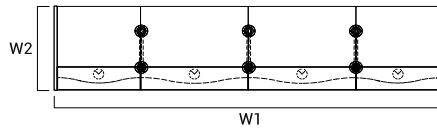
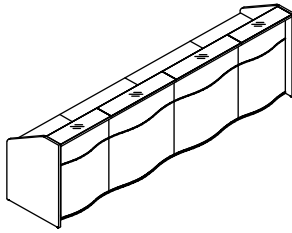

INDEX SYMBOL	DIMENSIONS [mm]					PRICE EUR				COMPONENTS
	W <sub>1</sub>	W <sub>2</sub>	D <sub>1</sub>	D <sub>2</sub>	H		kg	m <sup>3</sup>	pcs	
LUV21	3496	770	-	-	1103	3 030,-	160.0	0.835	13	LUV05L+2xLUV02+2xLUV03 +LUV05P+3xNL41

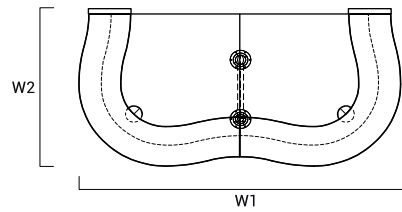
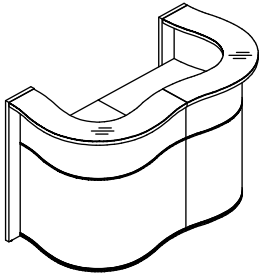

INDEX SYMBOL	DIMENSIONS [mm]					PRICE EUR				COMPONENTS
	W <sub>1</sub>	W <sub>2</sub>	D <sub>1</sub>	D <sub>2</sub>	H		kg	m <sup>3</sup>	pcs	
LUV22	1624	841	-	-	1103	2 230,-	84.0	0.575	7	LUV08L+2xLUV04+LUV08P+NL41

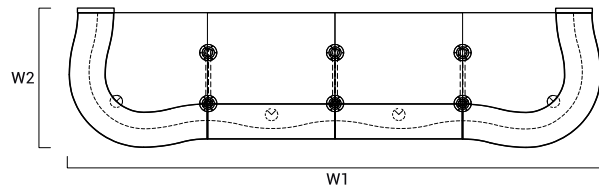
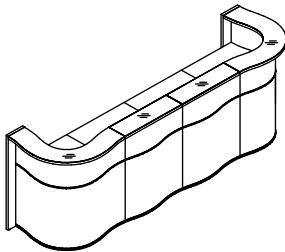

INDEX SYMBOL	DIMENSIONS [mm]					PRICE EUR				COMPONENTS
	W <sub>1</sub>	W <sub>2</sub>	D <sub>1</sub>	D <sub>2</sub>	H		kg	m <sup>3</sup>	pcs	
LUV23	3124	841	-	-	1103	3 600,-	146.0	0.957	13	LUV08L+2xLUV04+2xLUV02 +LUV08P+3xNL41
LUV24	3564	841	-	-	1103	3 740,-	154.0	1.031	13	LUV08L+2xLUV04+2xLUV03 +LUV08P+3xNL41

DESCRIPTION

- NET WEIGHT

VOLUME

NUMBER OF PACKAGES



RECEPTION DESKS SYSTEMS

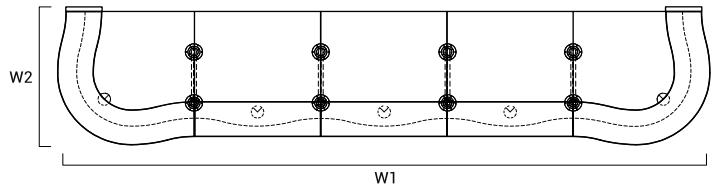
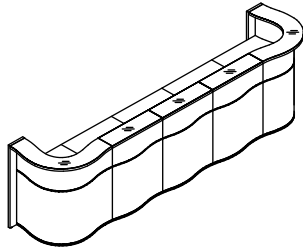

INDEX SYMBOL	DIMENSIONS [mm]					PRICE EUR				COMPONENTS
	W <sub>1</sub>	W <sub>2</sub>	D <sub>1</sub>	D <sub>2</sub>	H		kg	m <sup>3</sup>	pcs	
LUV25	3874	841	-	-	1103	4 285,-	177.0	1.148	16	LUV08L+2xLUV04+3xLUV02 +LUV08P+4xNL41
LUV26	4534	841	-	-	1103	4 495,-	189.0	1.259	16	LUV08L+2xLUV04+3xLUV03 +LUV08P+4xNL41

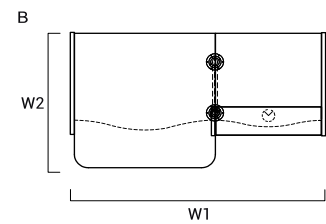
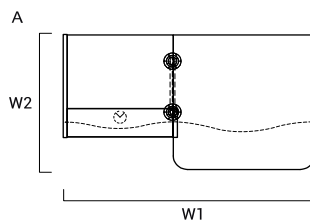
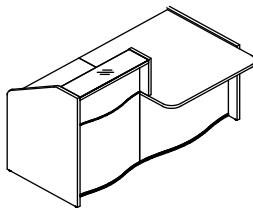

INDEX SYMBOL	DIMENSIONS [mm]					PRICE EUR				COMPONENTS
	W <sub>1</sub>	W <sub>2</sub>	D <sub>1</sub>	D <sub>2</sub>	H		kg	m <sup>3</sup>	pcs	
A LUV27L	1776	1019	-	-	1103	1 575,-	87.0	0.368	8	LUV06L+LUV01+LUV07L+LUV02 +LUV05P+NL41
B LUV27P	1776	1019	-	-	1103	1 575,-	87.0	0.368	8	LUV05L+LUV02+LUV07P+LUV01 +LUV06P+NL41
A LUV271L	1576	1019	-	-	1103	1 505,-	81.0	0.342	8	LUV06L+LUV01+LUV07L+LUV02 +LUV05P+NL41
B LUV271P	1576	1019	-	-	1103	1 505,-	81.0	0.342	8	LUV05L+LUV02+LUV07P+LUV01 +LUV06P+NL41
A LUV28L	1996	1019	-	-	1103	1 645,-	91.0	0.405	8	LUV06L+LUV01+LUV07L+LUV03 +LUV05P+NL41
B LUV28P	1996	1019	-	-	1103	1 645,-	91.0	0.405	8	LUV05L+LUV03+LUV07P+LUV01 +LUV06P+NL41
A LUV281L	1776	1019	-	-	1103	1 575,-	85.0	0.379	8	LUV06L+LUV01+LUV07L+LUV03 +LUV05P+NL41
B LUV281P	1776	1019	-	-	1103	1 575,-	85.0	0.379	8	LUV05L+LUV03+LUV07P+LUV01 +LUV06P+NL41

DESCRIPTION

- NET WEIGHT

VOLUME

NUMBER OF PACKAGES

RECEPTION DESKS SYSTEMS

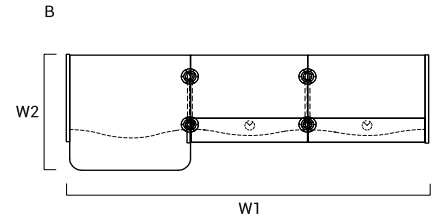
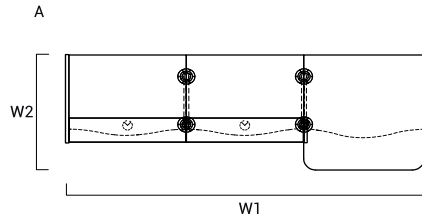
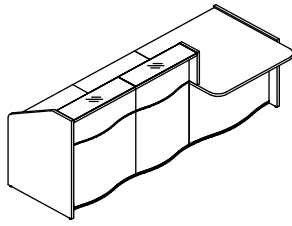

INDEX SYMBOL	DIMENSIONS [mm]					PRICE EUR				COMPONENTS
	W <sub>1</sub>	W <sub>2</sub>	D <sub>1</sub>	D <sub>2</sub>	H		kg	m <sup>3</sup>	pcs	
A LUV29L	2526	1019	-	-	1103	2 230,-	118.0	0.559	11	LUV06L+LUV01+LUV07L+2xLUV02+LUV05P+NL41
B LUV29P	2526	1019	-	-	1103	2 230,-	118.0	0.559	11	LUV05L+2xLUV02+LUV07P+LUV01+LUV06P+NL41
A LUV291L	2326	1019	-	-	1103	2 160,-	112.0	0.533	11	LUV06L+LUV011+LUV07L+2xLUV02+LUV05P+NL41
B LUV291P	2326	1019	-	-	1103	2 160,-	112.0	0.533	11	LUV05L+2xLUV02+LUV07P+LUV011+LUV06P+NL41
A LUV30L	2966	1019	-	-	1103	2 370,-	126.0	0.633	11	LUV06L+LUV01+LUV07L+2xLUV03+LUV05P+NL41
B LUV30P	2966	1019	-	-	1103	2 370,-	126.0	0.633	11	LUV05L+2xLUV03+LUV07P+LUV01+LUV06P+NL41
A LUV301L	2766	1019	-	-	1103	2 300,-	120.0	0.607	11	LUV06L+LUV011+LUV07L+2xLUV03+LUV05P+NL41
B LUV301P	2766	1019	-	-	1103	2 300,-	120.0	0.607	11	LUV05L+2xLUV03+LUV07P+LUV011+LUV06P+NL41

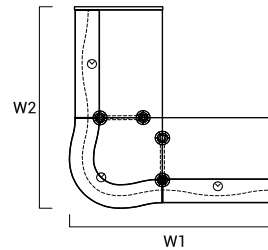
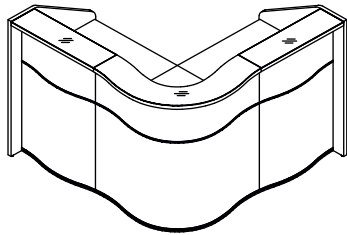

INDEX SYMBOL	DIMENSIONS [mm]					PRICE EUR				COMPONENTS
	W <sub>1</sub>	W <sub>2</sub>	D <sub>1</sub>	D <sub>2</sub>	H		kg	m <sup>3</sup>	pcs	
LUV35	1590	1590	-	-	1103	2 595,-	128.0	0.689	10	LUV05L+LUV02+LUV04+LUV02+LUV05P+2xNL41
LUV36	1810	1810	-	-	1103	2 735,-	136.0	0.763	10	LUV05L+LUV03+LUV04+LUV03+LUV05P+2xNL41

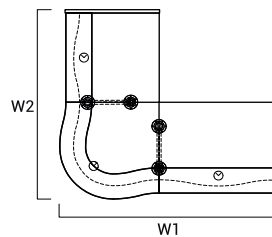
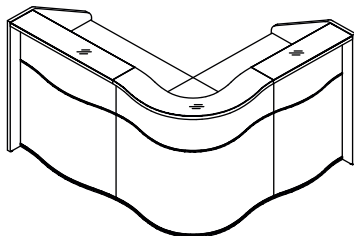

INDEX SYMBOL	DIMENSIONS [mm]					PRICE EUR				COMPONENTS
	W <sub>1</sub>	W <sub>2</sub>	D <sub>1</sub>	D <sub>2</sub>	H		kg	m <sup>3</sup>	pcs	
LUV37	1810	1590	-	-	1103	2 665,-	132.0	0.726	10	LUV05L+LUV03+LUV04+LUV02+LUV05P+2xNL41

DESCRIPTION

- NET WEIGHT

VOLUME

NUMBER OF PACKAGES

RECEPTION DESKS SYSTEMS

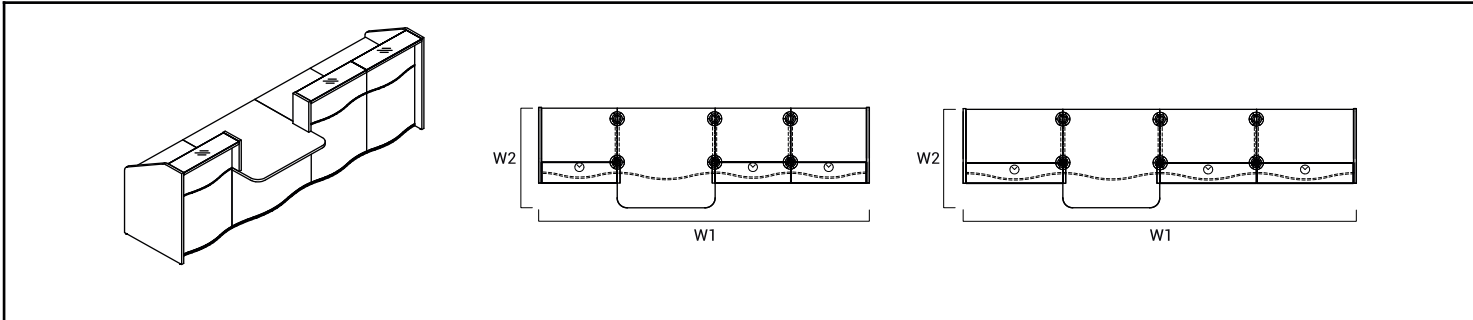

INDEX SYMBOL	DIMENSIONS [mm]					PRICE EUR				COMPONENTS
	W <sub>1</sub>	W <sub>2</sub>	D <sub>1</sub>	D <sub>2</sub>	H		kg	m <sup>3</sup>	pcs	
LUV31	3276	1019	-	-	1103	3 015,-	155.0	0.759	15	LUV05L+2xLUV02+LUV07P+LUV01+LUV07L+LUV02+LUV05P+3xNL41
LUV311	3076	1019	-	-	1103	2 945,-	149.0	0.733	15	LUV05L+2xLUV02+LUV07P+LUV011+LUV07L+LUV02+LUV05P+3xNL41
LUV32	3936	1019	-	-	1103	3 225,-	167.0	0.870	15	LUV05L+2xLUV03+LUV07P+LUV01+LUV07L+LUV03+LUV05P+3xNL41
LUV321	3736	1019	-	-	1103	3 155,-	161.0	0.844	15	LUV05L+2xLUV03+LUV07P+LUV011+LUV07L+LUV03+LUV05P+3xNL41

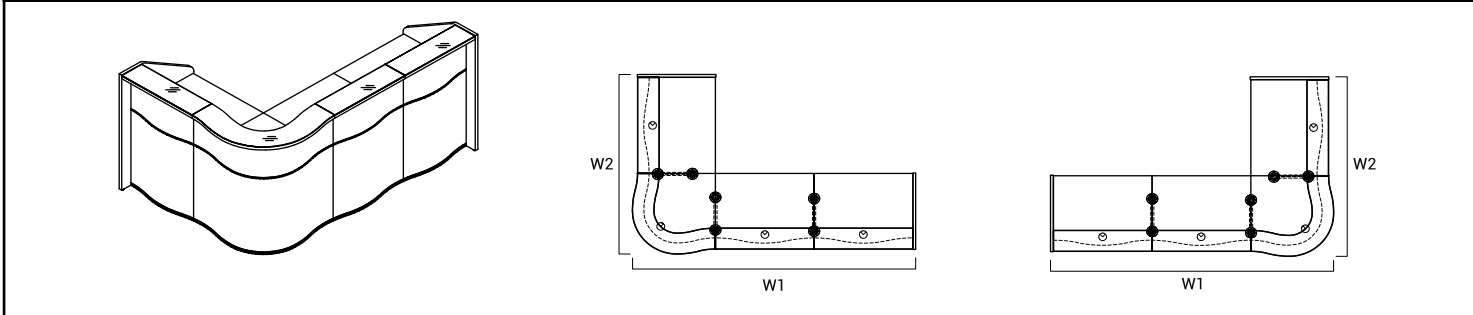

INDEX SYMBOL	DIMENSIONS [mm]					PRICE EUR				COMPONENTS
	W <sub>1</sub>	W <sub>2</sub>	D <sub>1</sub>	D <sub>2</sub>	H		kg	m <sup>3</sup>	pcs	
LUV41	2340	1590	-	-	1103	3 280,-	159.0	0.879	13	LUV05L+2xLUV02+LUV04+LUV02+LUV05P+3xNL41
LUV42	2780	1810	-	-	1103	3 490,-	171.0	0.990	13	LUV05L+2xLUV03+LUV04+LUV03+LUV05P+3xNL41

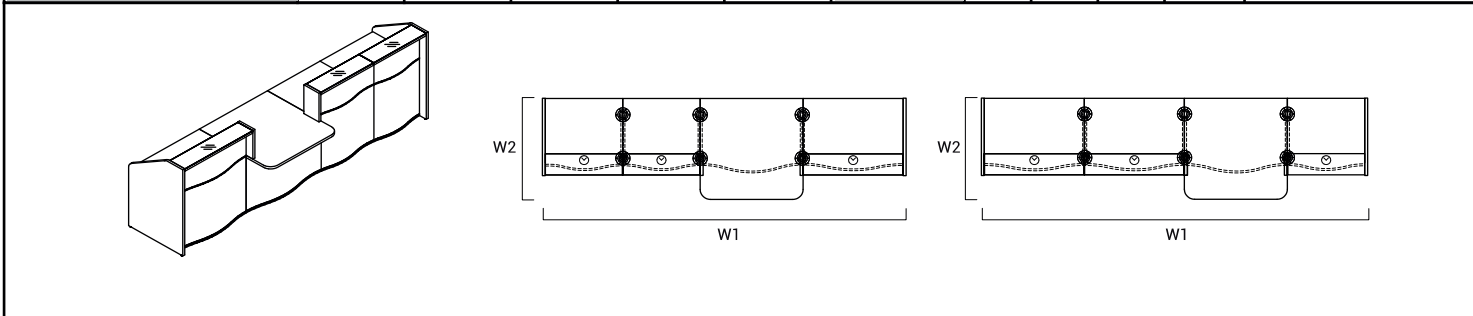

INDEX SYMBOL	DIMENSIONS [mm]					PRICE EUR				COMPONENTS
	W <sub>1</sub>	W <sub>2</sub>	D <sub>1</sub>	D <sub>2</sub>	H		kg	m <sup>3</sup>	pcs	
LUV33	3496	1019	-	-	1103	3 085,-	159.0	0.796	15	LUV05L+LUV03+LUV07P+LUV01+LUV07L+2xLUV02+LUV05P+3xNL41
LUV331	3296	1019	-	-	1103	3 015,-	153.0	0.770	15	LUV05L+LUV03+LUV07P+LUV011+LUV07L+2xLUV02+LUV05P+3xNL41
LUV34	3716	1019	-	-	1103	3 155,-	163.0	0.833	15	LUV05L+LUV02+LUV07P+LUV01+LUV07L+2xLUV03+LUV05P+3xNL41
LUV341	3516	1019	-	-	1103	3 085,-	157.0	0.807	15	LUV05L+LUV02+LUV07P+LUV011+LUV07L+2xLUV03+LUV05P+3xNL41

DESCRIPTION

- NET WEIGHT

VOLUME

NUMBER OF PACKAGES

RECEPTION DESKS SYSTEMS

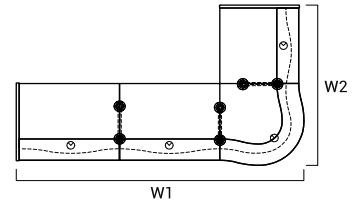
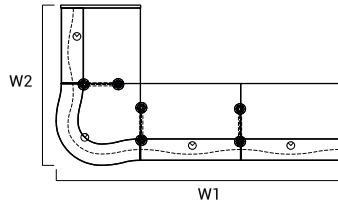
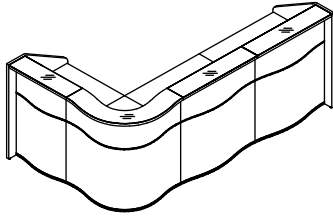

INDEX SYMBOL	DIMENSIONS [mm]					PRICE EUR				COMPONENTS
	W <sub>1</sub>	W <sub>2</sub>	D <sub>1</sub>	D <sub>2</sub>	H		kg	m <sup>3</sup>	pcs	
LUV43	2780	1591	-	-	1103	3 350,-	167.0	0.953	13	LUV05L+2xLUV03+LUV04+LUV02 +LUV05P+3xNL41
LUV44	2343	1813	-	-	1103	3 420,-	163.0	0.916	13	LUV05L+2xLUV02+LUV04+LUV03 +LUV05P+3xNL41

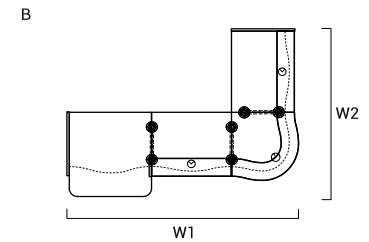
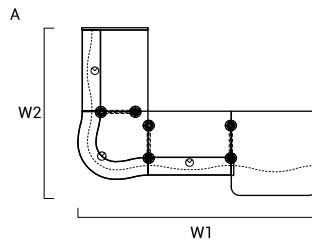
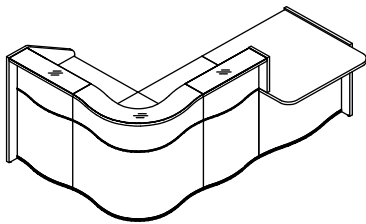

INDEX SYMBOL	DIMENSIONS [mm]					PRICE EUR				COMPONENTS
	W <sub>1</sub>	W <sub>2</sub>	D <sub>1</sub>	D <sub>2</sub>	H		kg	m <sup>3</sup>	pcs	
A LUV38L	2560	1590	-	-	1103	3 335,-	156.0	0.868	14	LUV06L+LUV01+LUV07L +LUV02+LUV04+LUV02+LUV05P +3xNL41
B LUV38P	2560	1590	-	-	1103	3 335,-	156.0	0.868	14	LUV05L+LUV02+LUV04+LUV02 +LUV07P+LUV01+LUV06P+3xNL41
A LUV381L	2360	1590	-	-	1103	3 265,-	150.0	0.842	14	LUV06L+LUV011+LUV07L+LUV02 +LUV04+LUV02+LUV05P+3xNL41
B LUV381P	2360	1590	-	-	1103	3 265,-	150.0	0.842	14	LUV05L+LUV02+LUV04+LUV02 +LUV07P+LUV011+LUV06P +3xNL41
A LUV39L	2780	1810	-	-	1103	3 475,-	164.0	0.942	14	LUV06L+LUV01+LUV07L+LUV03 +LUV04+LUV03+LUV05P+3xNL41
B LUV39P	2780	1810	-	-	1103	3 475,-	164.0	0.942	14	LUV05L+LUV03+LUV04+LUV03 +LUV07P+LUV01+LUV06P+3xNL41
A LUV391L	2580	1810	-	-	1103	3 405,-	158.0	0.916	14	LUV06L+LUV011+LUV07L+LUV03 +LUV04+LUV03+LUV05P+3xNL41
B LUV391P	2580	1810	-	-	1103	3 405,-	158.0	0.916	14	LUV05L+LUV03+LUV04+LUV03 +LUV07P+LUV011+LUV06P +3xNL41

DESCRIPTION

- NET WEIGHT

VOLUME

NUMBER OF PACKAGES

RECEPTION DESKS SYSTEMS

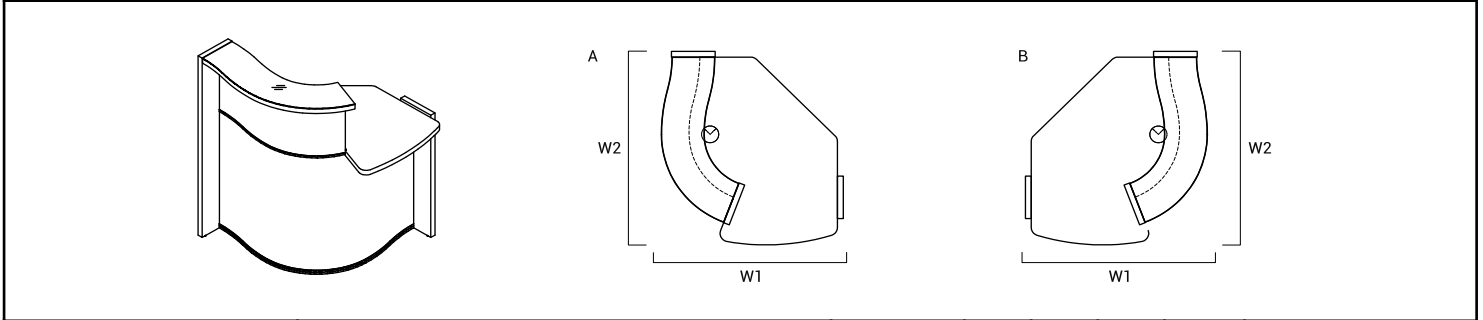

INDEX SYMBOL	DIMENSIONS [mm]					PRICE EUR				COMPONENTS
	W <sub>1</sub>	W <sub>2</sub>	D <sub>1</sub>	D <sub>2</sub>	H		kg	m <sup>3</sup>	pcs	
A <b>LUV49L</b>	858	925	-	-	1103	1 105,-	39.0	0.231	2	
B <b>LUV49P</b>	858	925	-	-	1103	1 105,-	39.0	0.231	2	

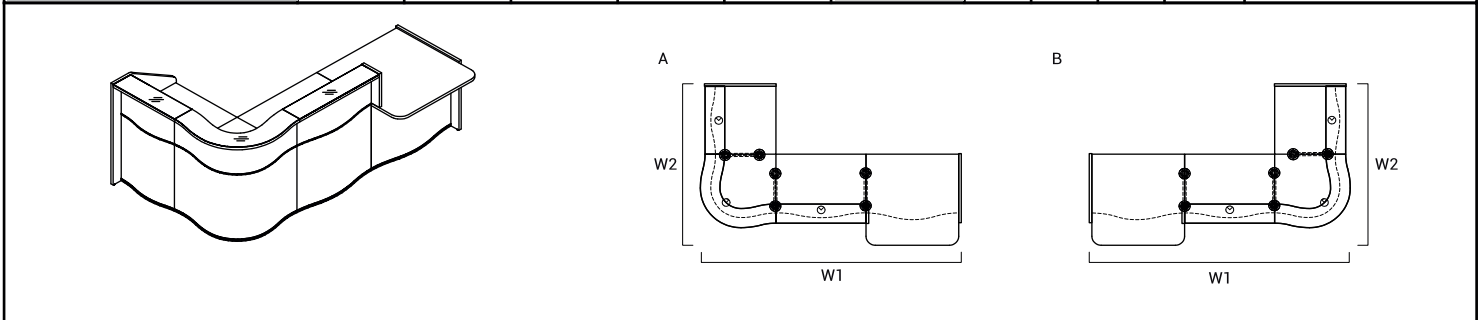

INDEX SYMBOL	DIMENSIONS [mm]					PRICE EUR				COMPONENTS
	W <sub>1</sub>	W <sub>2</sub>	D <sub>1</sub>	D <sub>2</sub>	H		kg	m <sup>3</sup>	pcs	
A <b>LUV40L</b>	2780	1792	-	-	1103	3 405,-	160.0	0.905	14	LUV06L+LUV01+LUV07L+LUV03 +LUV04+LUV02+LUV05P+3xNL41
B <b>LUV40P</b>	2780	1792	-	-	1103	3 405,-	160.0	0.905	14	LUV05L+LUV02+LUV04+LUV03 +LUV07P+LUV01+LUV06P+3xNL41
A <b>LUV401L</b>	2580	1792	-	-	1103	3 335,-	154.0	0.879	14	LUV06L+LUV011+LUV07L+LUV03 +LUV04+LUV02+LUV05P+3xNL41
B <b>LUV401P</b>	2580	1792	-	-	1103	3 335,-	154.0	0.879	14	LUV05L+LUV02+LUV04+LUV03 +LUV07P+LUV011+LUV06P +3xNL41

DESCRIPTION

- NET WEIGHT

VOLUME

NUMBER OF PACKAGES

RECEPTION DESKS SYSTEMS

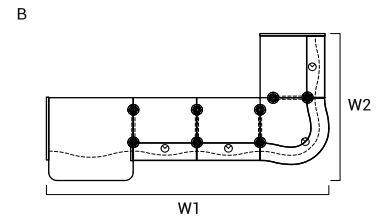
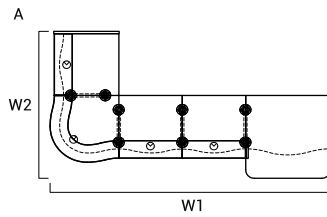
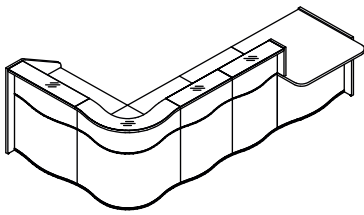

INDEX SYMBOL	DIMENSIONS [mm]					PRICE EUR	kg	m3	pcs	COMPONENTS
	W <sub>1</sub>	W <sub>2</sub>	D <sub>1</sub>	D <sub>2</sub>	H					
A LUV45L	3310	1792	-	-	1103	4 020,-	187.0	1.059	17	LUV06L+LUV01+LUV07L+2xLUV02+LUV04+LUV02+LUV05P+4xNL41
B LUV45P	3310	1792	-	-	1103	4 020,-	187.0	1.059	17	LUV05L+LUV02+LUV04+2xLUV02+LUV07P+LUV01+LUV06P+4xNL41
A LUV451L	3110	1792	-	-	1103	3 950,-	181.0	1.033	17	LUV06L+LUV011+LUV07L+2xLUV02+LUV04+LUV02+LUV05P+4xNL41
B LUV451P	3110	1792	-	-	1103	3 950,-	181.0	1.033	17	LUV05L+LUV02+LUV04+2xLUV02+LUV07P+LUV011+LUV06P+4xNL41
A LUV46L	3750	1810	-	-	1103	4 230,-	199.0	1.169	17	LUV06L+LUV01+LUV07L+2xLUV03+LUV04+LUV03+LUV05P+4xNL41
B LUV46P	3750	1810	-	-	1103	4 230,-	199.0	1.169	17	LUV05L+LUV03+LUV04+2xLUV03+LUV07P+LUV01+LUV06P+4xNL41
A LUV461L	3550	1810	-	-	1103	4 160,-	193.0	1.144	17	LUV06L+LUV011+LUV07L+2xLUV03+LUV04+LUV03+LUV05P+4xNL41
B LUV461P	3750	1810	-	-	1103	4 160,-	193.0	1.144	17	LUV05L+LUV03+LUV04+2xLUV03+LUV07P+LUV011+LUV06P+4xNL41

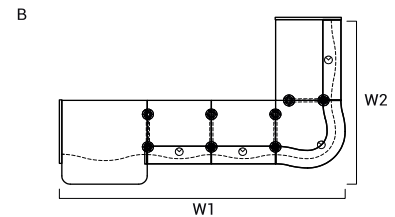
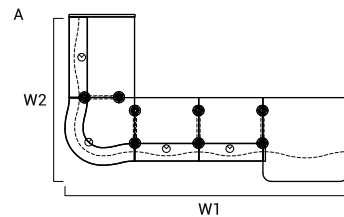
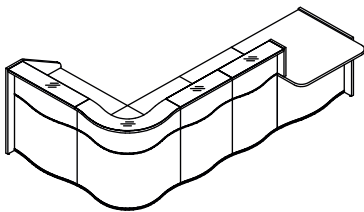



INDEX SYMBOL	DIMENSIONS [mm]					PRICE EUR	kg	m3	pcs	COMPONENTS
	W <sub>1</sub>	W <sub>2</sub>	D <sub>1</sub>	D <sub>2</sub>	H					
A LUV47L	3310	1810	-	-	1103	4 090,-	195.0	1.133	17	LUV06L+LUV01+LUV07L+2xLUV02+LUV04+LUV03+LUV05P+4xNL41
B LUV47P	3310	1810	-	-	1103	4 090,-	195.0	1.133	17	LUV05L+LUV03+LUV04+2xLUV02+LUV07P+LUV01+LUV06P+4xNL41
A LUV471L	3110	1810	-	-	1103	4 020,-	189.0	1.107	17	LUV06L+LUV011+LUV07L+2xLUV02+LUV04+LUV03+LUV05P+4xNL41
B LUV471P	3110	1810	-	-	1103	4 020,-	189.0	1.107	17	LUV05L+LUV03+LUV04+2xLUV02+LUV07P+LUV011+LUV06P+4xNL41
A LUV48L	3750	1792	-	-	1103	4 160,-	191.0	1.096	17	LUV06L+LUV01+LUV07L+2xLUV03+LUV04+LUV02+LUV05P+4xNL41
B LUV48P	3750	1792	-	-	1103	4 160,-	191.0	1.096	17	LUV05L+LUV02+LUV04+2xLUV03+LUV07P+LUV01+LUV06P+4xNL41
A LUV481L	3550	1792	-	-	1103	4 090,-	185.0	1.070	17	LUV06L+LUV011+LUV07L+2xLUV03+LUV04+LUV02+LUV05P+4xNL41
B LUV481P	3550	1792	-	-	1103	4 090,-	185.0	1.070	17	LUV05L+LUV02+LUV04+2xLUV03+LUV07P+LUV011+LUV06P+4xNL41

DESCRIPTION

- NET WEIGHT

VOLUME

NUMBER OF PACKAGES

PRODUCT ILLUSTRATION	DIMENSIONS [mm]			INDEX SYMBOL	PRICE EUR				COMMENTS
	WIDTH	DEPTH	HEIGHT			kg	m3	pcs	

COMPOSITION ELEMENTS

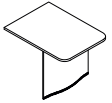
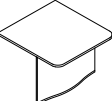
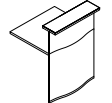
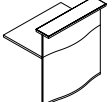
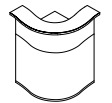
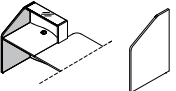
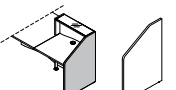
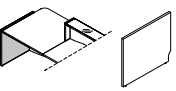
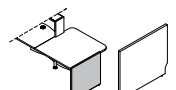
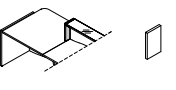
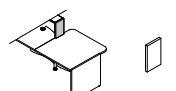

	750	1015	740	LUV011	620,-	22.0	0.092	2	
	970	1015	740	LUV01	690,-	28.0	0.118	2	
	750	763	1103	LUV02	655,-	29.0	0.128	2	
	970	763	1103	LUV03	725,-	33.0	0.165	2	
	815	815	1103	LUV04	1 045,-	36.0	0.246	2	
	770	28	1103	LUV05L	90,-	15.0	0.030	1	left
	770	28	1103	LUV05P	90,-	15.0	0.030	1	right
	770	28	755	LUV06L	65,-	11.0	0.024	1	left
	770	28	755	LUV06P	65,-	11.0	0.024	1	right
	216	28	363	LUV07L	45,-	2.0	0.004	1	left
	216	28	363	LUV07P	45,-	2.0	0.004	1	right

DESCRIPTION



 - NET WEIGHT

 VOLUME

 NUMBER OF PACKAGES

PRODUCT ILLUSTRATION	DIMENSIONS [mm]			INDEX SYMBOL	PRICE EUR				COMMENTS
	WIDTH	DEPTH	HEIGHT			kg	m3	pcs	

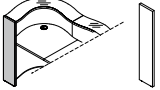
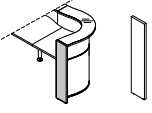
COMPOSITION ELEMENTS

	216	28	1103	LUV08L	55,-	5.0	0.010	1	left
	216	28	1103	LUV08P	55,-	5.0	0.010	1	right
	470	170	170	LUV09	150,-	1.7	0.014	0	67 - white pastel
	585	142	712	NL41	30,-	2.0	0.063	1	round profile leg

DESCRIPTION

 - NET WEIGHT

 VOLUME

 NUMBER OF PACKAGES





## TECHNICAL SPECIFICATION

### COLOURS

#### COUNTER TOP - GLASS



WHITE, LACOBEL

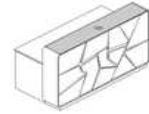

#### BODY

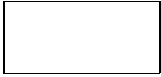

67 WHITE PASTEL

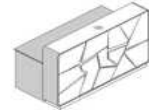

#### FRONT - MDF



MDF LACQUERED,  
GLOSS

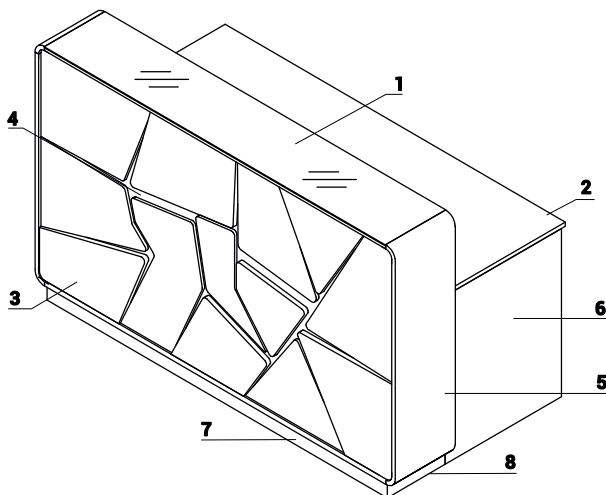
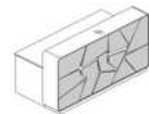

1. **Glass top** - glass LACOBEL 4mm
2. **Worktop** - MFC 28mm, PVC edge
3. **Front** - lacquered MDF (gloss) 12 - 16mm
4. **Light source** - RGBW LED, remote control
5. **Body** - MDF lacquered(gloss) 22mm
6. **Low side panel** - MFC 28mm, PVC edge
7. **Base**- laquered MFC - gloss
8. **Leveling** - 5mm range

ATTENTION - Possibility of ordering reception counter front panel in other RAL colours. For more information please ask customer service.

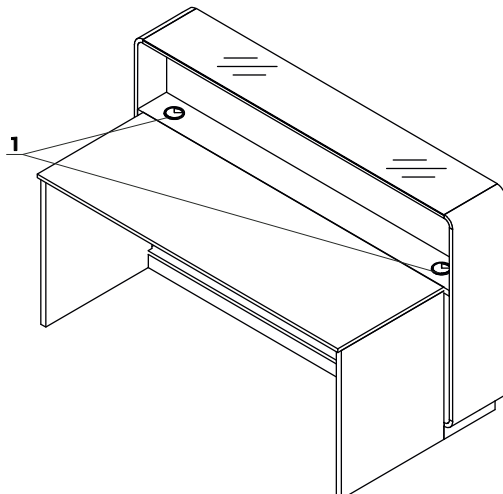

1. **Cable grommets** - Ø80mm

## TECHNICAL SPECIFICATION

### DIMENSIONS

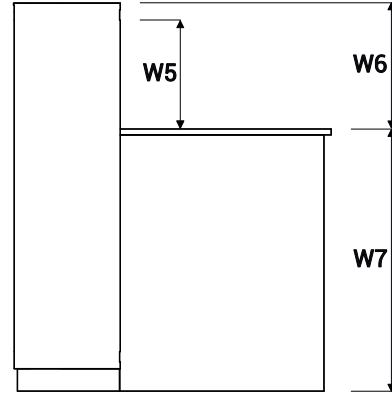
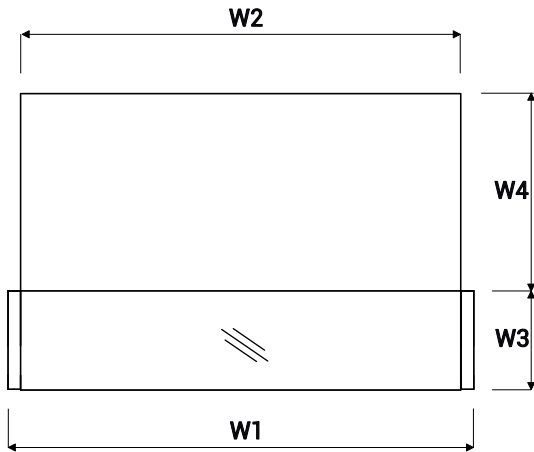

W1 - 1800mm | W2 - 1700mm | W3 - 300mm | W4 - 600mm | W5 - 344mm | W6 - 360mm | W7 - 740mm

PRODUCT ILLUSTRATION	DIMENSIONS [mm]			INDEX SYMBOL	PRICE EUR				COMMENTS
	WIDTH	DEPTH	HEIGHT			kg	m3	pcs	

### RECEPTION DESK

	1800	900	1100	<b>LAS18</b>	4 840,-	125.5	0.987	3	
--	------	-----	------	--------------	---------	-------	-------	---	--

## TECHNICAL SPECIFICATION

### COLOURS

#### COUNTER TOP - GLASS



WHITE, LACOBEL



#### BODY

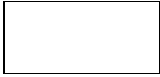

67 WHITE PASTEL

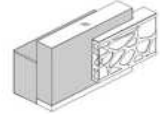

#### FRONT - METAL

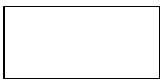

M015 WHITE  
SEMI-MATTE

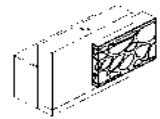

#### FRONT - PLEXIGLASS



PLEXIGLASS  
WHITE

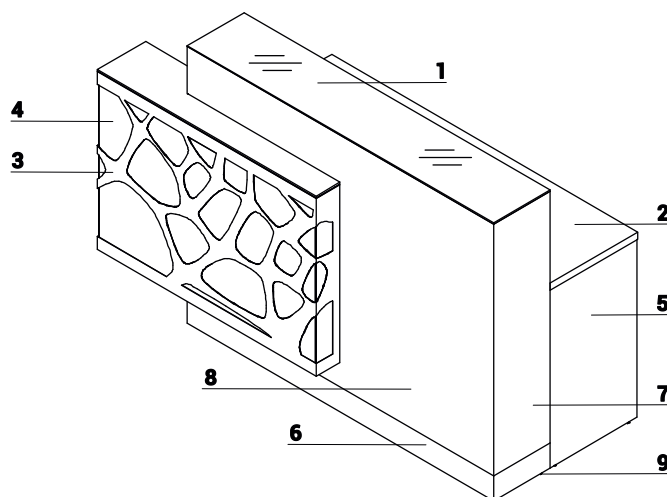
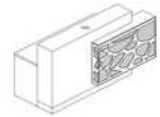

1. **Glass top** - glass LACOBEL 4mm
2. **Worktop** - MFC 28mm, PVC edge
3. **Front** - powder coated steel and plexiglas
4. **Light source** - RGBW LED, remote control
5. **Low side panel** - MFC 28mm, PVC edge
6. **Kick plate** - HPL - brushed aluminum
7. **Body** - MFC 18mm+ HPL - mat
8. **Front** - MFC 28mm + HPL - mat 0,8mm, PVC edge
9. **Leveling** - 5mm range

TECHNICAL SPECIFICATION

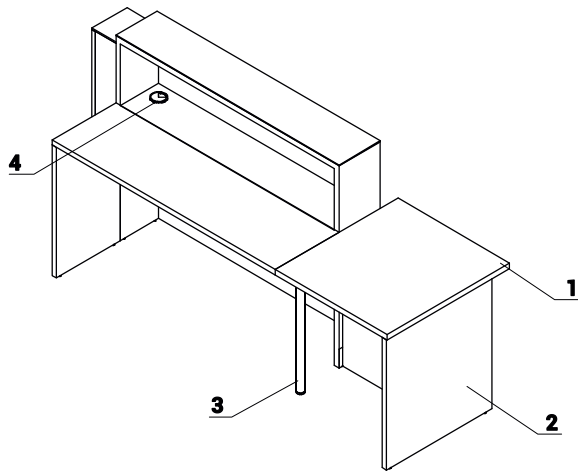

- 1. **Worktop** - MFC 28mm, PVC edge
- 2. **Low side panel** - MFC 28mm, PVC edge
- 3. **Supporting leg NE41**- required for connecting the tops
- 4. **Cable grommets** - Ø80mm

DIMENSIONS

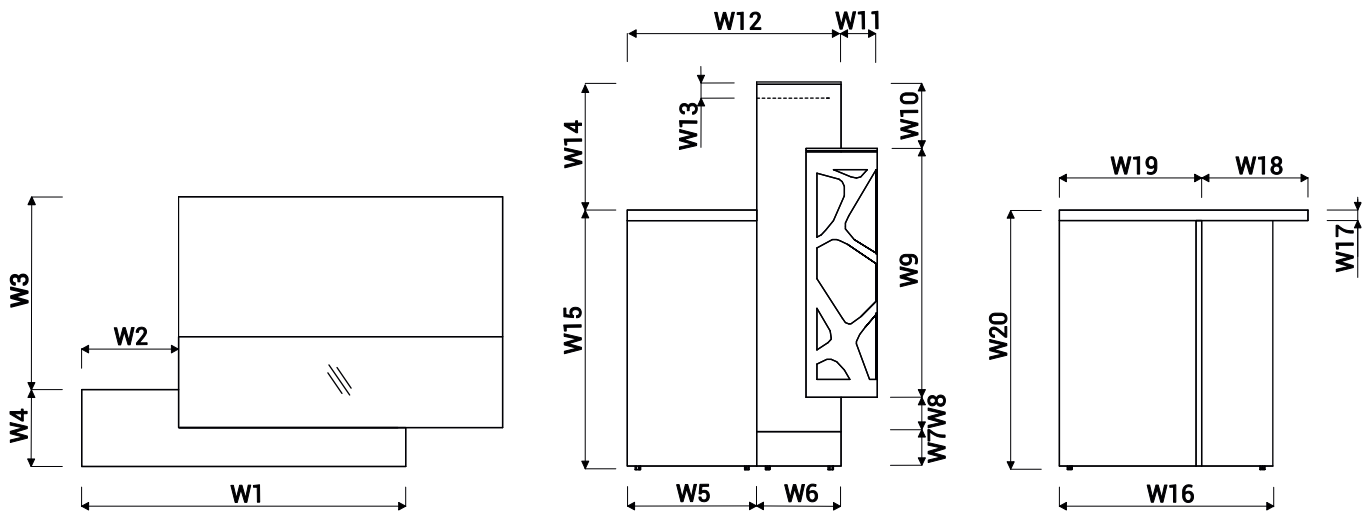

W1 - 1000mm | W2 - 300mm | W3 - 550mm | W4 - 222mm | W5 - 400mm | W6 - 260mm | W7 - 100mm | W8 - 97mm | W9 - 705mm | W10 - 184mm | W11 - 110mm | W12 - 660mm | W13 - 34mm | W14 - 365mm | W15 - 740mm | W16 - 660mm | W17 - 28mm | W18 - 318mm | W19 - 452mm | W20 - 740mm

RECEPTION DESKS SYSTEMS

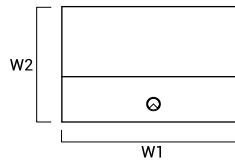
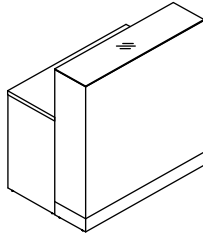

INDEX SYMBOL	DIMENSIONS [mm]					PRICE EUR				COMPONENTS
	W <sub>1</sub>	W <sub>2</sub>	D <sub>1</sub>	D <sub>2</sub>	H		kg	m <sup>3</sup>	pcs	
<b>LOG10G</b>	1000	660	-	-	1105	970,-	50.0	0.582	2	LOG10B+LOG10K
<b>LOG14G</b>	1400	660	-	-	1105	1 360,-	55.0	0.815	2	LOG14B+LOG14K

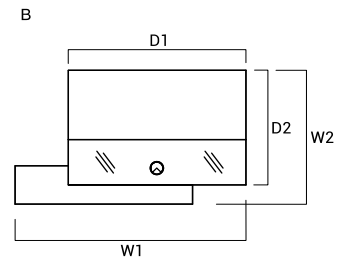
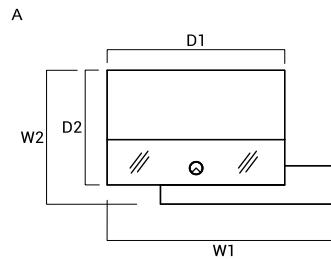
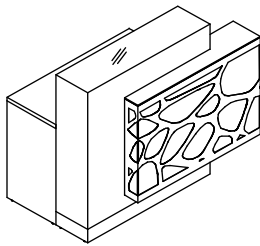

INDEX SYMBOL	DIMENSIONS [mm]					PRICE EUR				COMPONENTS
	W <sub>1</sub>	W <sub>2</sub>	D <sub>1</sub>	D <sub>2</sub>	H		kg	m <sup>3</sup>	pcs	
<b>A LOG11LG</b>	1300	770	1000	660	1105	2 495,-	75.5	0.740	4	LOG10B+LOG10K+LOG01L
<b>B LOG11PG</b>	1300	770	1000	660	1105	2 495,-	75.5	0.740	4	LOG10B+LOG10K+LOG01P

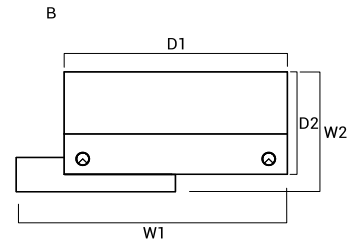
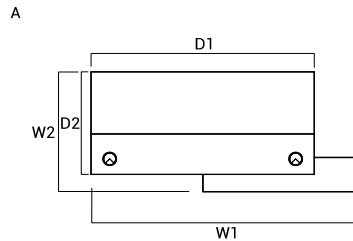
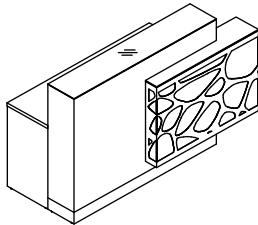

INDEX SYMBOL	DIMENSIONS [mm]					PRICE EUR				COMPONENTS
	W <sub>1</sub>	W <sub>2</sub>	D <sub>1</sub>	D <sub>2</sub>	H		kg	m <sup>3</sup>	pcs	
<b>A LOG12LG</b>	1700	770	1400	660	1105	2 885,-	80.5	0.973	4	LOG14B+LOG14K+LOG01L
<b>B LOG12PG</b>	1700	770	1400	660	1105	2 885,-	80.5	0.973	4	LOG14B+LOG14K+LOG01P

DESCRIPTION

- NET WEIGHT

VOLUME

NUMBER OF PACKAGES

RECEPTION DESKS SYSTEMS

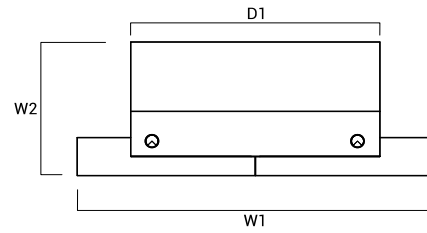
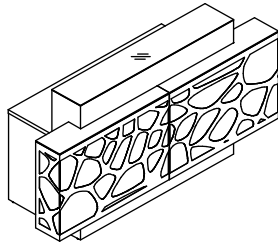

INDEX SYMBOL	DIMENSIONS [mm]					PRICE EUR				COMPONENTS
	W <sub>1</sub>	W <sub>2</sub>	D <sub>1</sub>	D <sub>2</sub>	H		kg	m <sup>3</sup>	pcs	
<b>LOG13G</b>	2000	770	1400	-	1105	4 410,-	106.0	1.132	6	LOG14B+LOG14K+LOG01L+LOG01P

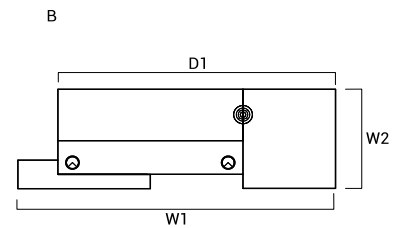
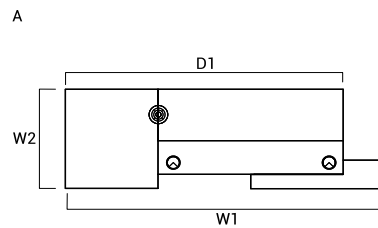
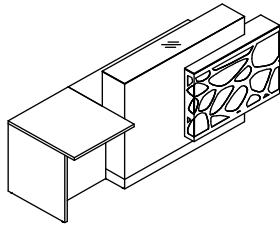

INDEX SYMBOL	DIMENSIONS [mm]					PRICE EUR				COMPONENTS
	W <sub>1</sub>	W <sub>2</sub>	D <sub>1</sub>	D <sub>2</sub>	H		kg	m <sup>3</sup>	pcs	
<b>A LOG14PLG</b>	2400	770	2100	-	1105	3 505,-	93.8	1.007	6	LOG01L+LOG14K+LOG14B+LOG07+NE41L
<b>B LOG14PPG</b>	2400	770	2100	-	1105	3 505,-	93.8	1.007	6	LOG07+LOG14B+LOG14K+LOG01P+NE41L

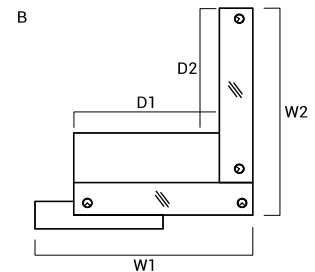
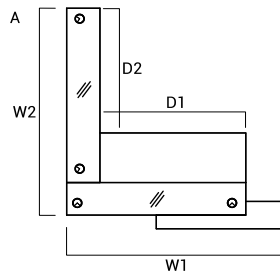
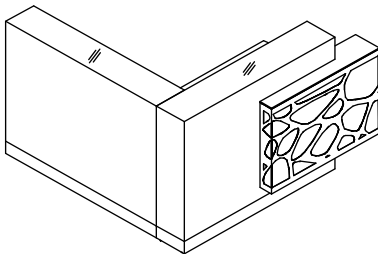

INDEX SYMBOL	DIMENSIONS [mm]					PRICE EUR				COMPONENTS
	W <sub>1</sub>	W <sub>2</sub>	D <sub>1</sub>	D <sub>2</sub>	H		kg	m <sup>3</sup>	pcs	
<b>A LOG16LG</b>	1700	1660	1140	1000	1105	3 860,-	120.5	1.297	5	LOG01L+2xLOG14K+LOG11B
<b>B LOG16PG</b>	1700	1770	-	-	1105	3 860,-	120.5	1.297	5	2xLOG14K+LOG11B+LOG01P

DESCRIPTION

- NET WEIGHT

VOLUME

NUMBER OF PACKAGES

RECEPTION DESKS SYSTEMS

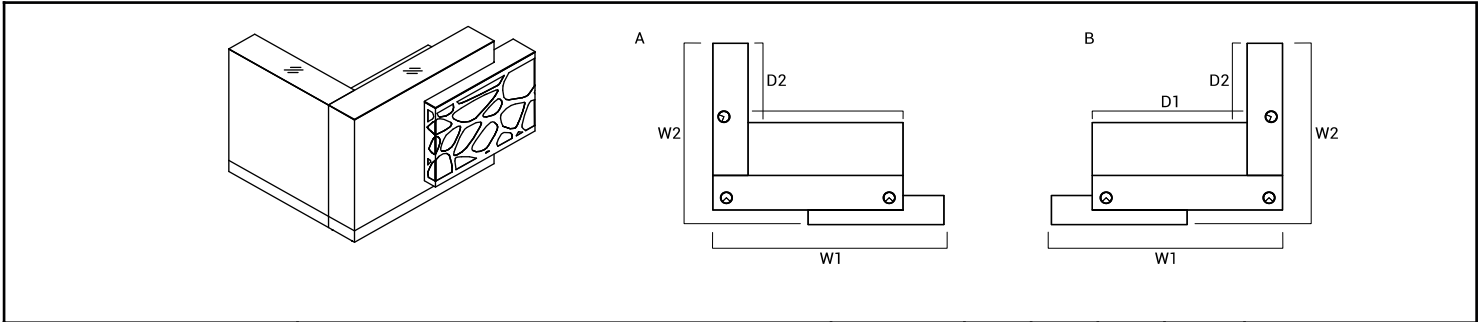

INDEX SYMBOL	DIMENSIONS [mm]					PRICE EUR	kg	m3	pcs	COMPONENTS
	W <sub>1</sub>	W <sub>2</sub>	D <sub>1</sub>	D <sub>2</sub>	H					
A <b>LOG18LG</b>	1700	1370	1140	600	1105	3 555,-	115.5	1.182	5	LOG01L+LOG14K+LOG11B+LOG10K
B <b>LOG18PG</b>	1700	1370	-	-	1105	3 555,-	115.5	1.182	5	LOG10K+LOG11B+LOG14K+LOG01P

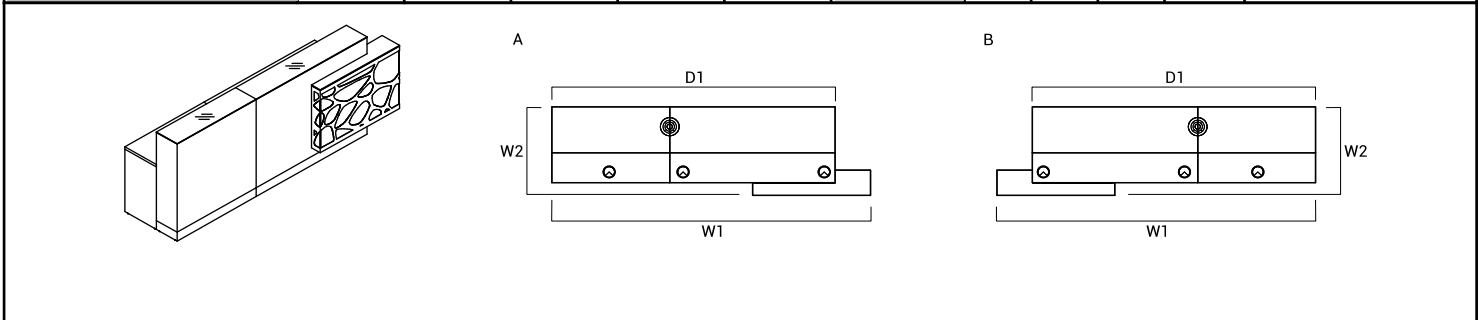

INDEX SYMBOL	DIMENSIONS [mm]					PRICE EUR	kg	m3	pcs	COMPONENTS
	W <sub>1</sub>	W <sub>2</sub>	D <sub>1</sub>	D <sub>2</sub>	H					
A <b>LOG19LG</b>	2700	770	2400	-	1105	3 885,-	131.8	1.557	7	LOG01L+LOG14K+LOG10K+LOG14B+LOG10B+NE41L
B <b>LOG19PG</b>	2700	770	2400	-	1105	3 885,-	131.8	1.557	7	LOG10B+LOG14B+LOG10K+LOG14K+LOG01P+NE41L

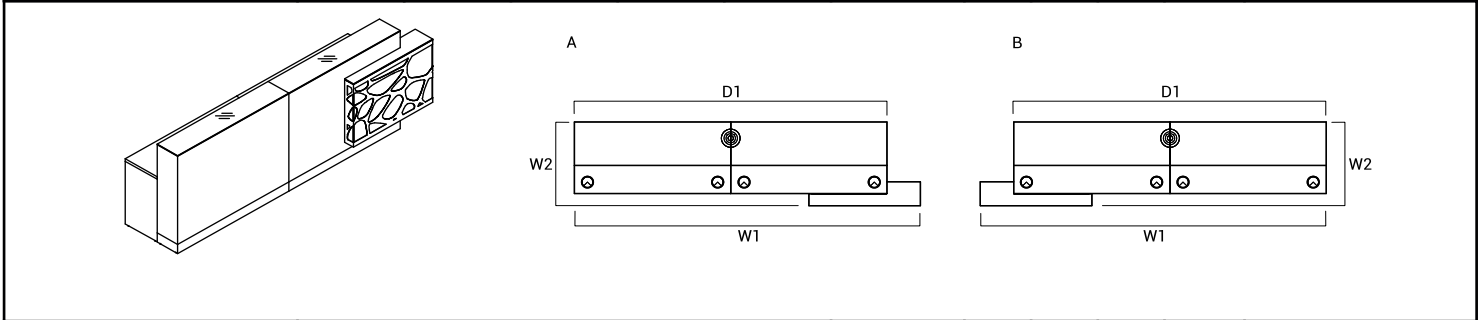

INDEX SYMBOL	DIMENSIONS [mm]					PRICE EUR	kg	m3	pcs	COMPONENTS
	W <sub>1</sub>	W <sub>2</sub>	D <sub>1</sub>	D <sub>2</sub>	H					
A <b>LOG20LG</b>	3100	770	2800	-	1105	4 275,-	136.8	1.790	7	LOG01L+2xLOG14K+2xLOG14B+NE41L
B <b>LOG20PG</b>	3100	770	2800	-	1105	4 275,-	136.8	1.790	7	2xLOG14B+2xLOG14K+LOG01P+NE41L

DESCRIPTION

- NET WEIGHT

VOLUME

NUMBER OF PACKAGES



RECEPTION DESKS SYSTEMS

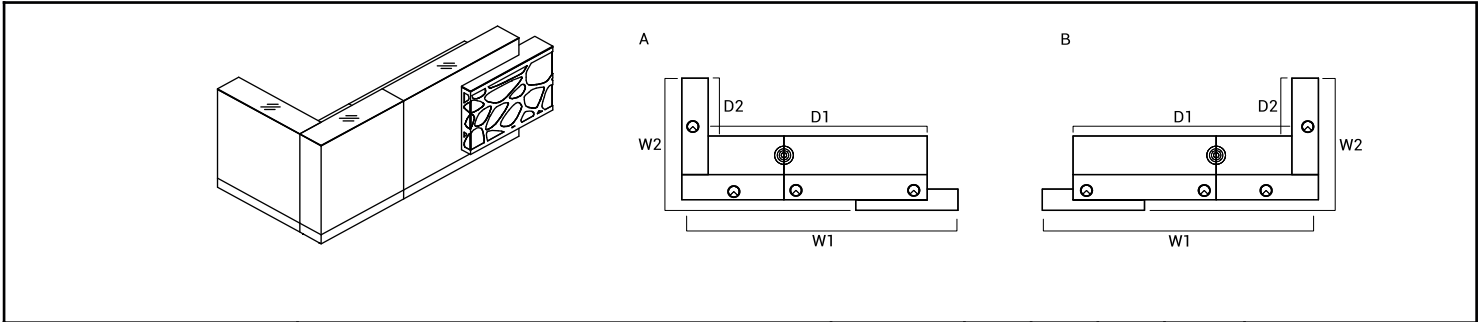

INDEX SYMBOL	DIMENSIONS [mm]					PRICE EUR	kg	m3	pcs	COMPONENTS
	W <sub>1</sub>	W <sub>2</sub>	D <sub>1</sub>	D <sub>2</sub>	H					
A <b>LOG21LG</b>	2700	1370	2140	600	1105	4 400,-	162.8	1.555	8	LOG01L+LOG14K+2xLOG10K +LOG14B+LOG08B+NE41L
B <b>LOG21PG</b>	2700	1370	2140	600	1105	4 400,-	162.8	1.555	8	2xLOG10K+LOG08B+LOG14B +LOG14K+LOG01P+NE41L

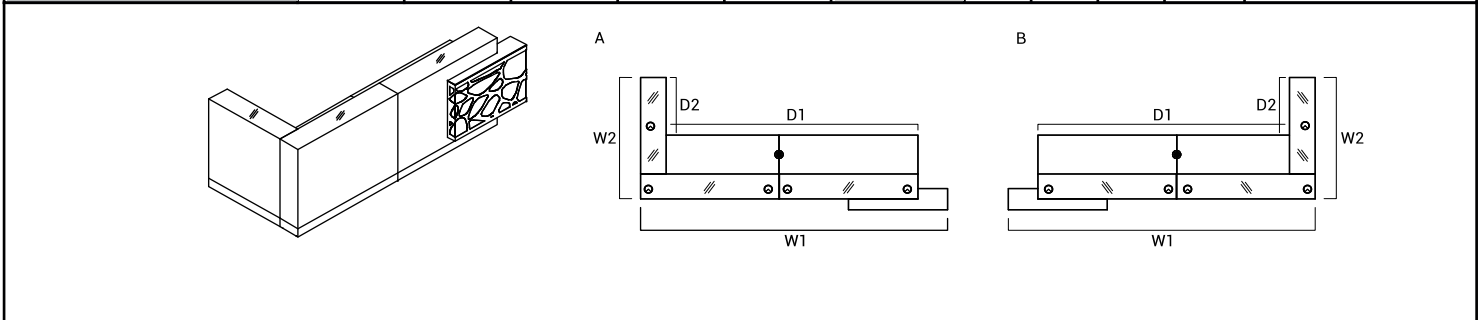

INDEX SYMBOL	DIMENSIONS [mm]					PRICE EUR	kg	m3	pcs	COMPONENTS
	W <sub>1</sub>	W <sub>2</sub>	D <sub>1</sub>	D <sub>2</sub>	H					
A <b>LOG22LG</b>	3100	1370	2540	600	1105	4 945,-	171.8	1.999	8	LOG01L+2xLOG14K+LOG14B +LOG11B+LOG10K+NE41L
B <b>LOG22PG</b>	3100	1370	2540	600	1105	4 945,-	171.8	1.999	8	LOG10K+LOG11B+LOG14B +2xLOG14K+LOG01P+NE41L

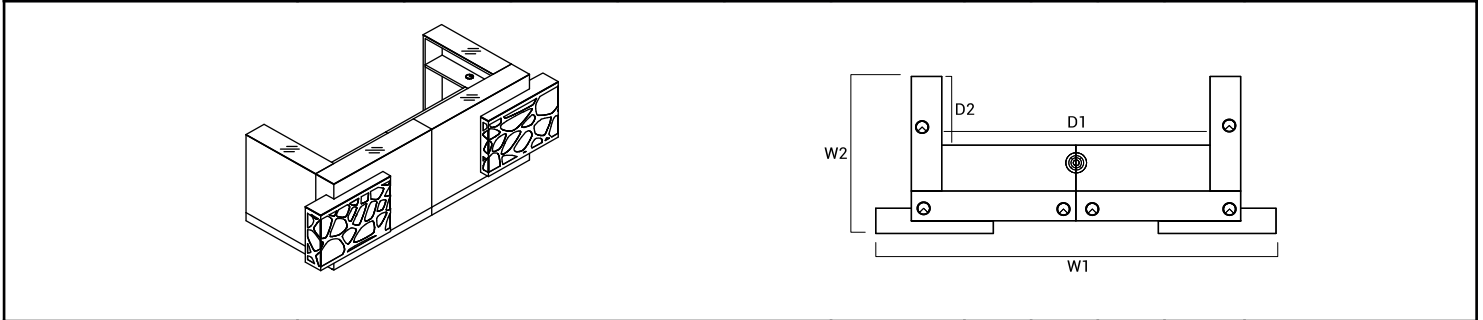

INDEX SYMBOL	DIMENSIONS [mm]					PRICE EUR	kg	m3	pcs	COMPONENTS
	W <sub>1</sub>	W <sub>2</sub>	D <sub>1</sub>	D <sub>2</sub>	H					
<b>LOG23G</b>	3400	1370	2280	600	1105	7 140,-	232.3	2.366	11	2xLOG10K+2xLOG11B+2xLOG14K +LOG01L+LOG01P+NE41L

DESCRIPTION

- NET WEIGHT

VOLUME

NUMBER OF PACKAGES

RECEPTION DESKS SYSTEMS

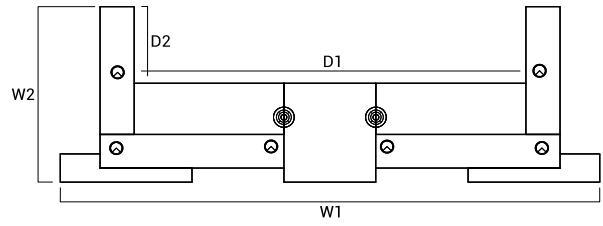
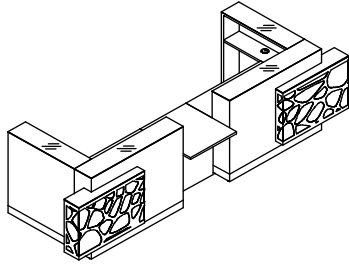

INDEX SYMBOL	DIMENSIONS [mm]					PRICE EUR				COMPONENTS
	W <sub>1</sub>	W <sub>2</sub>	D <sub>1</sub>	D <sub>2</sub>	H		kg	m <sup>3</sup>	pcs	
<b>LOG24G</b>	4100	1370	-	-	1105	7 760,-	245.6	2.401	13	2xLOG10K+2xLOG14K+2xLOG11B +LOG07+LOG01L+LOG01P +2xNE41L

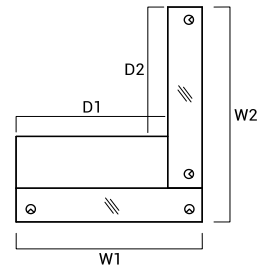
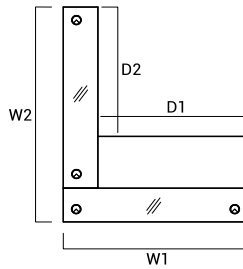
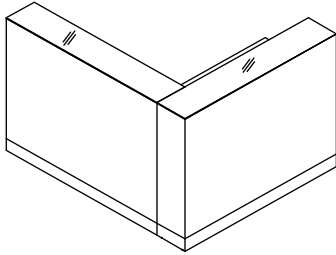

INDEX SYMBOL	DIMENSIONS [mm]					PRICE EUR				COMPONENTS
	W <sub>1</sub>	W <sub>2</sub>	D <sub>1</sub>	D <sub>2</sub>	H		kg	m <sup>3</sup>	pcs	
<b>LOG15</b>	1400	1660	-	-	1105	2 335,-	95.0	1.138	3	2xLOG14K+LOG11B

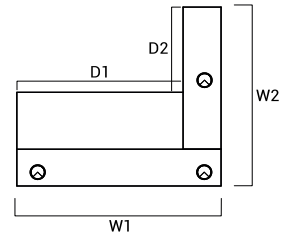
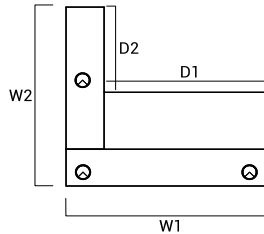
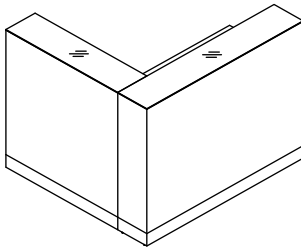

INDEX SYMBOL	DIMENSIONS [mm]					PRICE EUR				COMPONENTS
	W <sub>1</sub>	W <sub>2</sub>	D <sub>1</sub>	D <sub>2</sub>	H		kg	m <sup>3</sup>	pcs	
<b>LOG17</b>	1400	1260	-	-	1105	2 030,-	90.0	1.024	3	LOG11B+LOG14K+LOG10K

DESCRIPTION

- NET WEIGHT

VOLUME

NUMBER OF PACKAGES

RECEPTION DESKS SYSTEMS

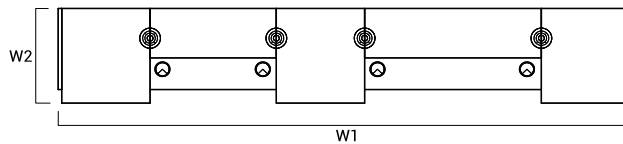
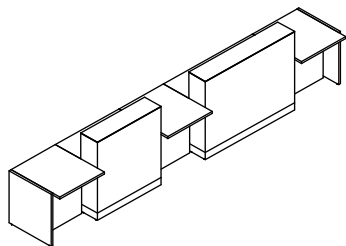



INDEX SYMBOL	DIMENSIONS [mm]					PRICE EUR				COMPONENTS
	W <sub>1</sub>	W <sub>2</sub>	D <sub>1</sub>	D <sub>2</sub>	H		kg	m <sup>3</sup>	pcs	
<b>LOG25</b>	4556	770	-	-	1105	4 220,-	146.2	1.501	11	3xLOG07+LOG14B+LOG14K +LOG10B+LOG10K+4xNE41L

DESCRIPTION







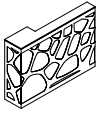
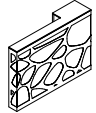

- NET WEIGHT

VOLUME

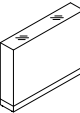
NUMBER OF PACKAGES

PRODUCT ILLUSTRATION	DIMENSIONS [mm]			INDEX SYMBOL	PRICE EUR					COMMENTS
	WIDTH	DEPTH	HEIGHT			kg	m3	pcs		

## COMPOSITION ELEMENTS

	728	770	740	<b>LOG07</b>	590,-	13.3	0.034	2		universal element
	1000	220	710	<b>LOG01P</b>	1 525,-	25.5	0.158	2		right
	1000	220	710	<b>LOG01L</b>	1 525,-	25.5	0.158	2		left
	1000	260	1105	<b>LOG10K</b>	715,-	35.0	0.286	1		
	1400	260	1105	<b>LOG14K</b>	1 020,-	40.0	0.400	1		
	740	400	28	<b>LOG08B</b>	55,-	11.0	0.008	1		
	1000	400	740	<b>LOG10B</b>	255,-	15.0	0.296	1		
	1140	400	740	<b>LOG11B</b>	295,-	15.0	0.337	1		
	1400	400	740	<b>LOG14B</b>	340,-	15.0	0.414	1		
	40	40	712	<b>NE41L</b>	30,-	1.5	0.002	1		round profile leg

DESCRIPTION

 - NET WEIGHT

 VOLUME

 NUMBER OF PACKAGES



TECHNICAL SPECIFICATION

COLOURS

BODY ,COUNTER TOP, SUPPORTING LEG WHERE WORKTOPS CONNECT NL41



67 WHITE PASTEL

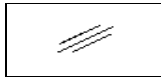

WHITE, TEMPERED GLASS

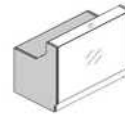

08 BLACK



BLACK, TEMPERED GLASS

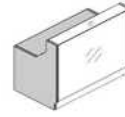

26 ALUMINUM SATINATO



SILVER, TEMPERED GLASS

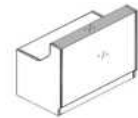
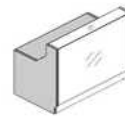

M009 ALUMINUM SEMI-MATTE



M015 WHITE SEMI-MATTE



M115 BLACK SEMI-MATTE



FRONT - GLASS



116 BLACK



117 WHITE



124 SILVER



134 DARK TURQUOISE



135 YELLOW



136 FUCHSIA

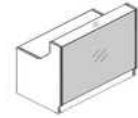

TAMBOUR STORAGE, STACK-ON WORKTOP STORAGE FOR RECEPTION DESK



08 BLACK



26 ALUMINUM SATINATO



67 WHITE PASTEL

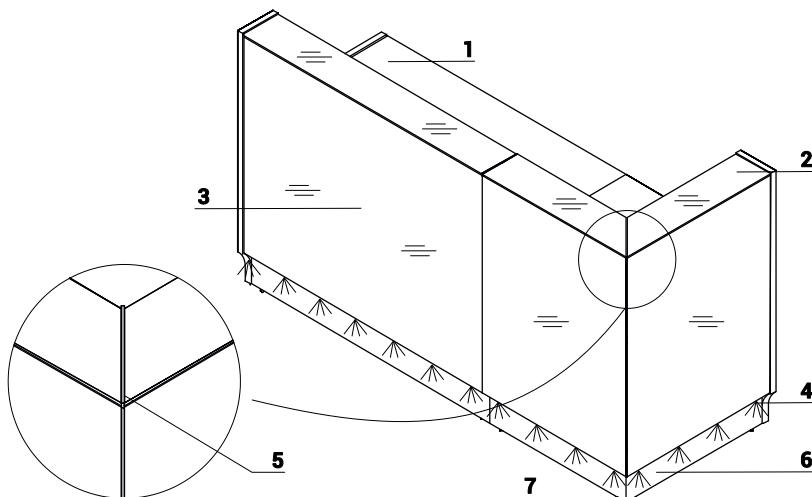

1. **Worktop** - MFC 28mm, PVC edge
2. **Top** - tempered optiwhite glass, 8mm - painted on bottom side
3. **Front** - glass LACOBEL 4mm
4. **LED illumination** - at the full length of the reception desk, cold white colour (verging on the blue shade)
5. **Corner slate** - stainless steel 4mm
6. **Kick plate** - HPL - brushed aluminum
7. **Leveling** - 5mm range

TECHNICAL SPECIFICATION

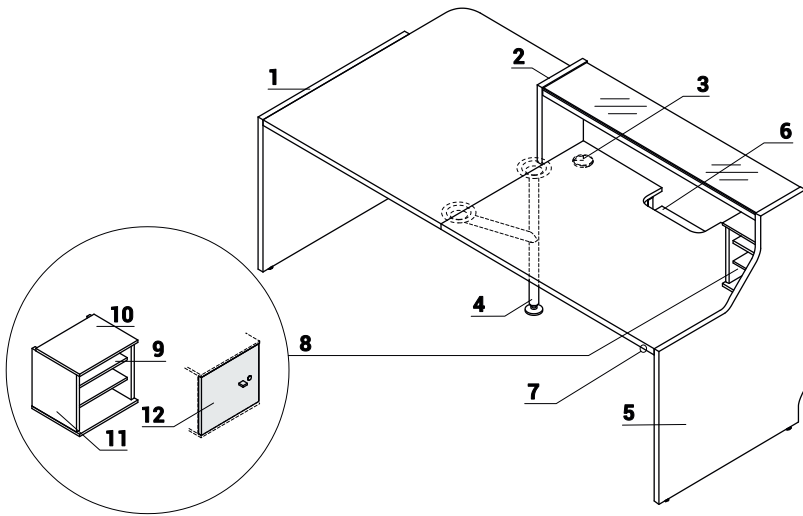

1. Low side panel - MFC 28mm, PVC edge
2. Side panel linking low and high fronts - MFC 28mm, PVC edge
3. Cable grommets - Ø80mm
4. Supporting leg NL41- required for connecting the tops
5. High side panel - MFC 28mm, PVC edge
6. Option with additional charge - working top with lowered monitor shelf - MFC 28mm, PVC edge
7. Light switch
8. LMS05 - reception desk storage; order separately
9. Shelf - MFC 12mm, PVC edge
10. Top - MFC 12mm, PVC edge
11. Body - MFC 18mm, PVC edge
12. Optional front with lock - universal (left, right) - MFC 18mm, PVC edge; - ordered as separate element

ENDING ELEMENTS APPLICATION

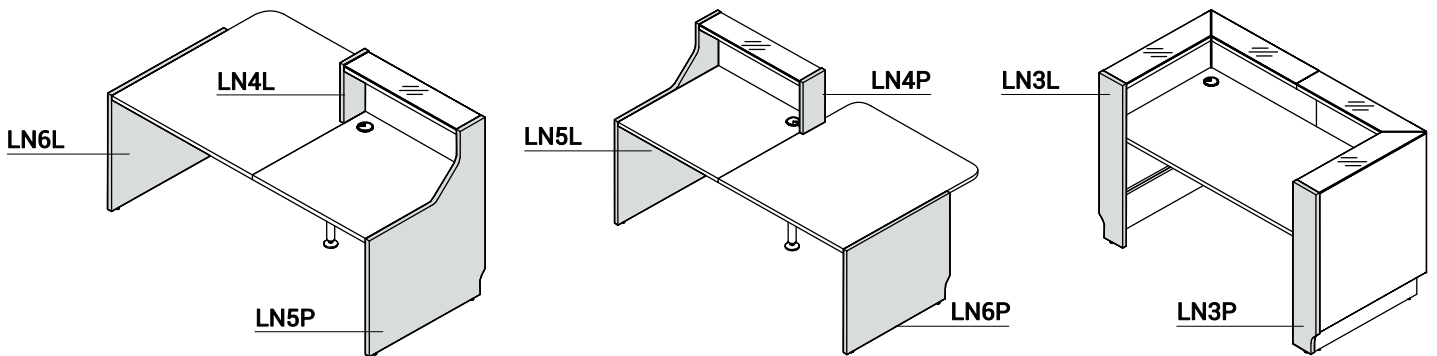

DIMENSIONS

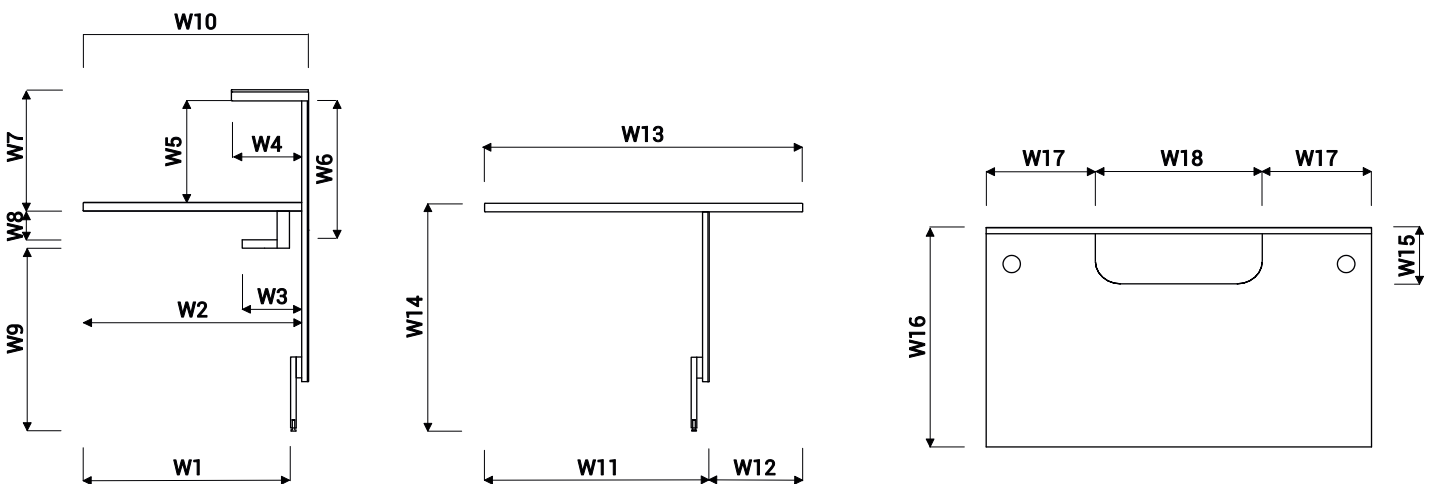

W1 - 763mm | W2 - 800mm | W3 - 200mm | W4 - 228mm | W5 - 329mm | W6 - 452mm | W7 - 365mm | W8 - 95mm | W9 - 589mm | W10 - 822mm |  
 W11 - 822mm | W12 - 300mm | W13 - 1122mm | W14 - 740mm | W15 - 200mm | W16 - 800mm | W17 340/540mm | W18 - 520mm

RECEPTION DESKS SYSTEMS

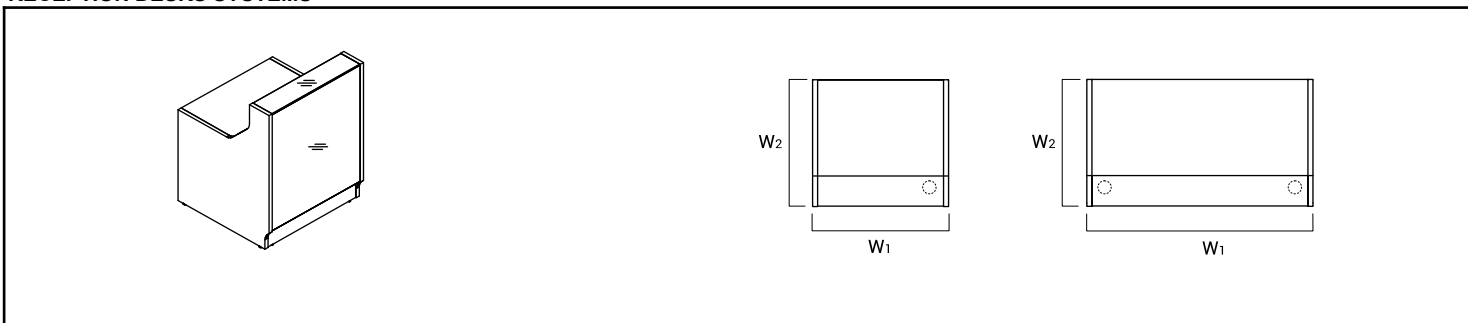

INDEX SYMBOL	DIMENSIONS [mm]					PRICE EUR				COMPONENTS
	W <sub>1</sub>	W <sub>2</sub>	D <sub>1</sub>	D <sub>2</sub>	H		kg	m <sup>3</sup>	pcs	
<b>LIN08</b>	856	824	-	-	1105	1 305,-	69.5	0.345	5	LN5L+LNB08+LN08+LN5P
<b>LIN13</b>	1256	824	-	-	1105	1 705,-	87.5	0.479	5	LN5L+LNB13+LN12+LN5P

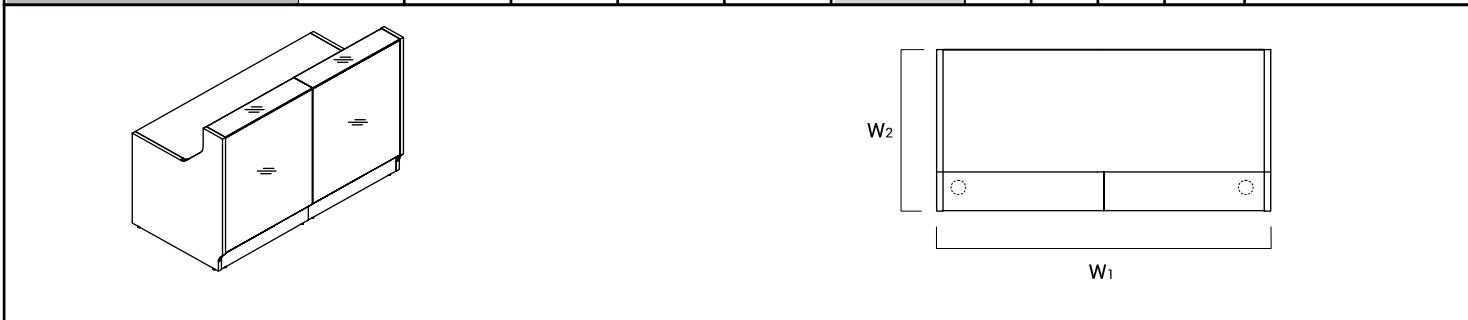

INDEX SYMBOL	DIMENSIONS [mm]					PRICE EUR				COMPONENTS
	W <sub>1</sub>	W <sub>2</sub>	D <sub>1</sub>	D <sub>2</sub>	H		kg	m <sup>3</sup>	pcs	
<b>LIN15</b>	1656	824	-	-	1105	2 385,-	107.0	0.623	7	LN5L+LNB15+2xLN08+LN5P

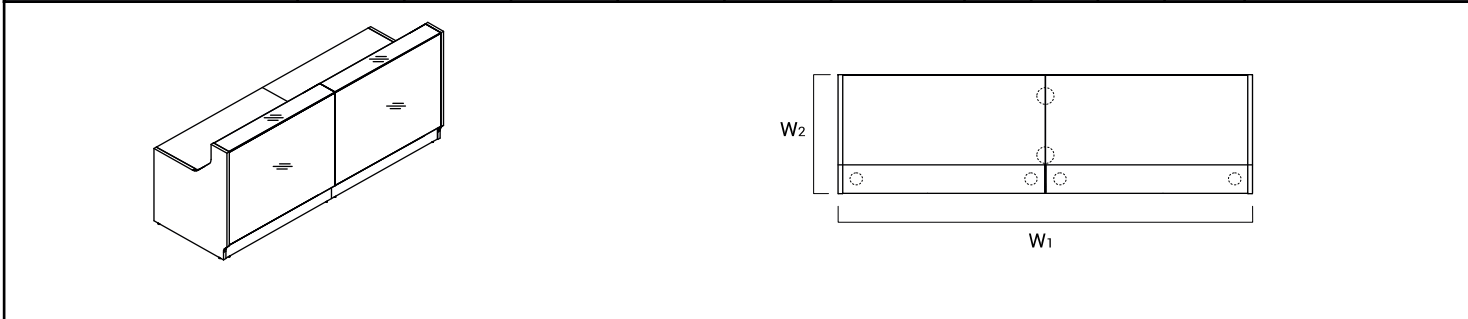

INDEX SYMBOL	DIMENSIONS [mm]					PRICE EUR				COMPONENTS
	W <sub>1</sub>	W <sub>2</sub>	D <sub>1</sub>	D <sub>2</sub>	H		kg	m <sup>3</sup>	pcs	
<b>LIN25</b>	2456	824	-	-	1105	3 250,-	149.0	0.955	9	LN5L+2xLNB13+2xLN12+LN5P+NL41

ADDITIONAL CHARGE

FEATURE	PRODUCT												COMMENTS
	LIN13	LIN15	LIN25							kg	m <sup>3</sup>	pcs	
MONITOR SHELF x 1	160,-	160,-	160,-							0.1	0.0001	1	
MONITOR SHELF x 2			320,-							0.9	0.0070	1	

DESCRIPTION

- NET WEIGHT

VOLUME

NUMBER OF PACKAGES



RECEPTION DESKS SYSTEMS

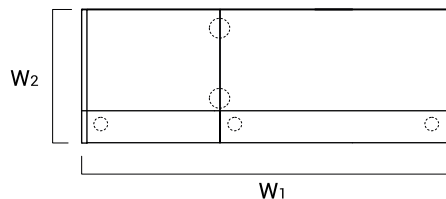
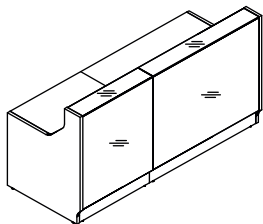

INDEX SYMBOL	DIMENSIONS [mm]					PRICE EUR				COMPONENTS
	W <sub>1</sub>	W <sub>2</sub>	D <sub>1</sub>	D <sub>2</sub>	H		kg	m <sup>3</sup>	pcs	
LIN20	2056	824	-	-	1105	2 850,-	134.0	0.826	10	LN5L+LNB13+LN08+LN12+LNB08 +LN5P+NL41

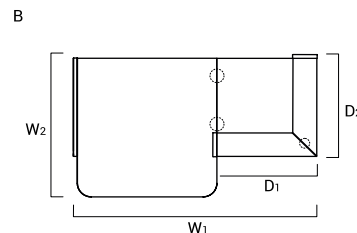
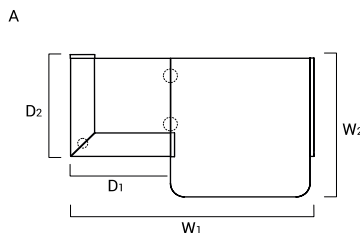
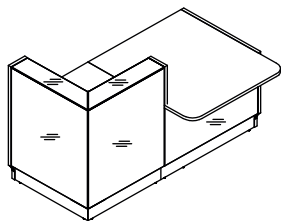

INDEX SYMBOL	DIMENSIONS [mm]					PRICE EUR				COMPONENTS
	W <sub>1</sub>	W <sub>2</sub>	D <sub>1</sub>	D <sub>2</sub>	H		kg	m <sup>3</sup>	pcs	
A LIN29L	1850	1150	822	850	1105	2 850,-	147.5	1.296	9	LN6L+LNU11+LN4L+LNB08+LN91 +LN3P+NL41
B LIN29P	1850	1150	822	850	1105	2 850,-	147.5	1.293	9	LN3L+LN91+LNB08+LN4P+LNU11 +LN6P+NL41
A LIN291L	1650	1150	822	850	1105	2 755,-	142.5	1.269	9	LN6L+LNU11+LN4L+LNB08+LN91 +LN3P+NL41
B LIN291P	1650	1150	822	850	1105	2 755,-	142.5	1.267	9	LN3L+LN91+LNB08+LN4P+LNU11 +LN6P+NL41

ADDITIONAL CHARGE

FEATURE	PRODUCT												COMMENTS
	LIN20									kg	m <sup>3</sup>	pcs	
MONITOR SHELF x 1	160,-									0.1	0.0001	1	
MONITOR SHELF x 2	320,-									0.9	0.0070	1	

DESCRIPTION

- NET WEIGHT

VOLUME

NUMBER OF PACKAGES

RECEPTION DESKS SYSTEMS

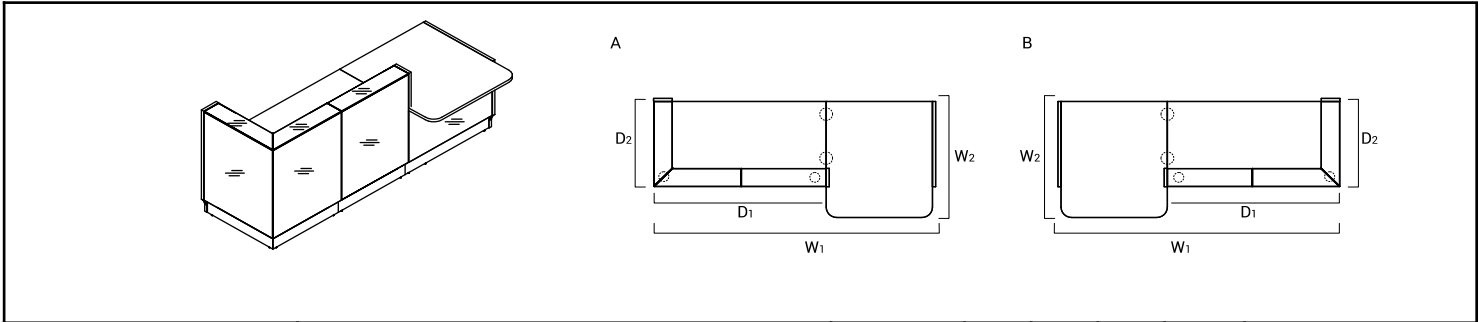

INDEX SYMBOL	DIMENSIONS [mm]					PRICE EUR	kg	m3	pcs	COMPONENTS
	W <sub>1</sub>	W <sub>2</sub>	D <sub>1</sub>	D <sub>2</sub>	H					
A <b>LIN35L</b>	2650	1150	1622	850	1105	3 930,-	188.0	1.580	12	LN6L+LNU11+LN4L+LN08+LNB15+LN91+LN3P+NL41
B <b>LIN35P</b>	2650	1150	1622	850	1105	3 930,-	188.0	1.577	12	LN3L+LN91+LNB15+LN08+LN4P+LNU11+LN6P+NL41
A <b>LIN351L</b>	2450	1150	1622	850	1105	3 835,-	183.0	1.553	12	LN6L+LNU11+LN4L+LN08+LNB15+LN91+LN3P+NL41
B <b>LIN351P</b>	2450	1150	1622	850	1105	3 835,-	183.0	1.550	12	LN3L+LN91+LNB15+LN08+LN4P+LNU11+LN6P+NL41

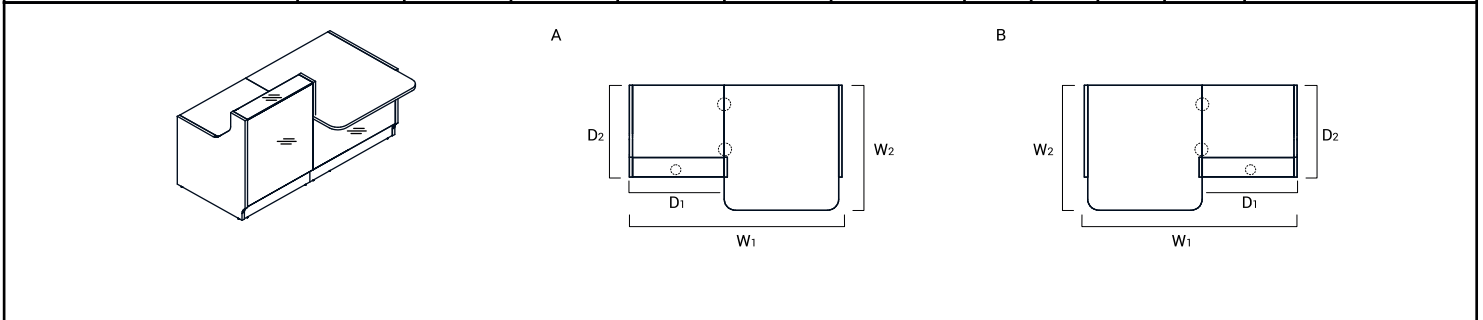

INDEX SYMBOL	DIMENSIONS [mm]					PRICE EUR	kg	m3	pcs	COMPONENTS
	W <sub>1</sub>	W <sub>2</sub>	D <sub>1</sub>	D <sub>2</sub>	H					
A <b>LIN33L</b>	1856	1122	828	824	1105	2 335,-	103.5	0.562	9	LN6L+LNU11+LN4L+LN08+LNB08+LNSP+NL41
B <b>LIN33P</b>	1856	1122	828	824	1105	2 335,-	103.5	0.560	9	LN5L+LNB08+LN08+LN4P+LNU11+LN6P+NL41
A <b>LIN331L</b>	1656	1122	828	824	1105	2 240,-	98.5	0.536	9	LN6L+LNU11+LN4L+LN08+LNB08+LNSP+NL41
B <b>LIN331P</b>	1656	1122	828	824	1105	2 240,-	98.5	0.533	9	LN5L+LNB08+LN08+LN4P+LNU11+LN6P+NL41

ADDITIONAL CHARGE

FEATURE	PRODUCT								kg	m3	pcs	COMMENTS
	LIN35L	LIN35P	LIN351L	LIN351P								
MONITOR SHELF x 1	160,-	160,-	160,-	160,-					0.1	0.0001	1	

DESCRIPTION

⚖️ - NET WEIGHT

📦 VOLUME

📦 NUMBER OF PACKAGES

RECEPTION DESKS SYSTEMS

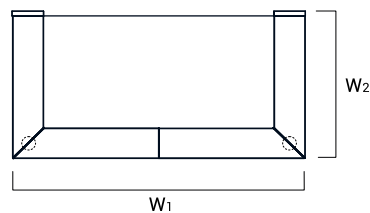
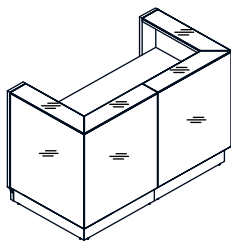

INDEX SYMBOL	DIMENSIONS [mm]					PRICE EUR				COMPONENTS
	W <sub>1</sub>	W <sub>2</sub>	D <sub>1</sub>	D <sub>2</sub>	H		kg	m <sup>3</sup>	pcs	
<b>LIN36</b>	1644	850	-	-	1105	3 415,-	198.0	2.096	8	LN3L+LNB15+2xLN91+LN3P

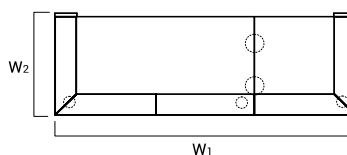
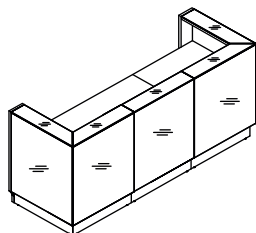

INDEX SYMBOL	DIMENSIONS [mm]					PRICE EUR				COMPONENTS
	W <sub>1</sub>	W <sub>2</sub>	D <sub>1</sub>	D <sub>2</sub>	H		kg	m <sup>3</sup>	pcs	
<b>LIN42</b>	2444	850	-	-	1105	4 560,-	241.5	2.439	12	LN3L+LNB08+2xLN91+LN08+LNB15+LN3P+NL41

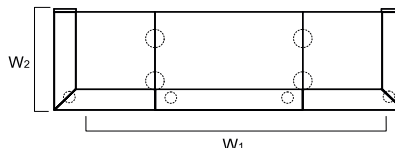
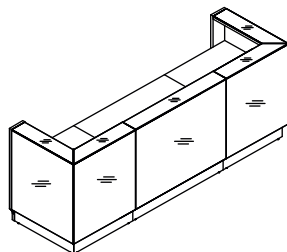

INDEX SYMBOL	DIMENSIONS [mm]					PRICE EUR				COMPONENTS
	W <sub>1</sub>	W <sub>2</sub>	D <sub>1</sub>	D <sub>2</sub>	H		kg	m <sup>3</sup>	pcs	
<b>LIN43</b>	2844	850	-	-	1105	5 025,-	265.5	2.637	14	LN3L+LNB08+2xLN91+LNB13+LN12+LNB08+LN3P+2xNL41

ADDITIONAL CHARGE

FEATURE	PRODUCT													COMMENTS
	LIN36	LIN42	LIN43								kg	m <sup>3</sup>	pcs	
MONITOR SHELF x 1	160,-	160,-	160,-								0.1	0.0001	1	

DESCRIPTION

- NET WEIGHT

VOLUME

NUMBER OF PACKAGES

RECEPTION DESKS SYSTEMS

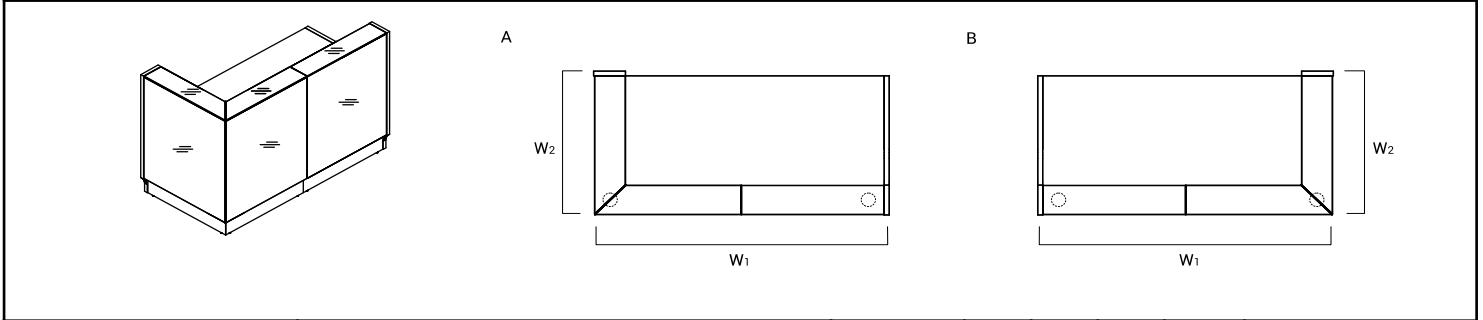

INDEX SYMBOL	DIMENSIONS [mm]					PRICE EUR				COMPONENTS
	W <sub>1</sub>	W <sub>2</sub>	D <sub>1</sub>	D <sub>2</sub>	H		kg	m <sup>3</sup>	pcs	
A <b>LIN37L</b>	1650	850	-	-	1105	2 900,-	154.0	1.362	8	LN5L+LN08+LNB15+LN91+LN3P
B <b>LIN37P</b>	1650	850	-	-	1105	2 900,-	154.0	1.362	8	LN3L+LN91+LNB15+LN08+LN5P

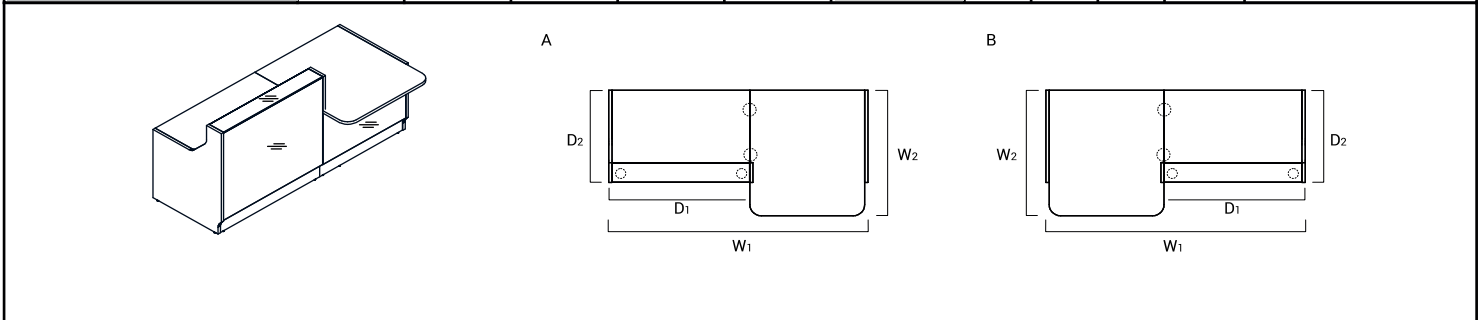

INDEX SYMBOL	DIMENSIONS [mm]					PRICE EUR				COMPONENTS
	W <sub>1</sub>	W <sub>2</sub>	D <sub>1</sub>	D <sub>2</sub>	H		kg	m <sup>3</sup>	pcs	
A <b>LIN34L</b>	2256	1122	1228	824	1105	2 735,-	124.5	0.701	10	LN6L+LNU11+LN4L+LN12+LNB13+LN5P+NL41
B <b>LIN34P</b>	2256	1122	1228	824	1105	2 735,-	124.5	0.698	10	LN5L+LNB13+LN12+LN4P+LNU11+LN6P+NL41
A <b>LIN341L</b>	2056	1122	1228	824	1105	2 640,-	119.5	0.674	10	LN6L+LNU11+LN4L+LN12+LNB13+LN5P+NL41
B <b>LIN341P</b>	2056	1122	1228	824	1105	2 640,-	119.5	0.672	10	LN5L+LNB13+LN12+LN4P+LNU11+LN6P+NL41

ADDITIONAL CHARGE

FEATURE	PRODUCT									COMMENTS
	LIN37L	LIN37P	LIN34L	LIN34P	LIN341L	LIN341P	kg	m <sup>3</sup>	pcs	
MONITOR SHELF x 1	160,-	160,-	160,-	160,-	160,-	160,-	0.1	0.0001	1	

DESCRIPTION

- NET WEIGHT

VOLUME

NUMBER OF PACKAGES

RECEPTION DESKS SYSTEMS

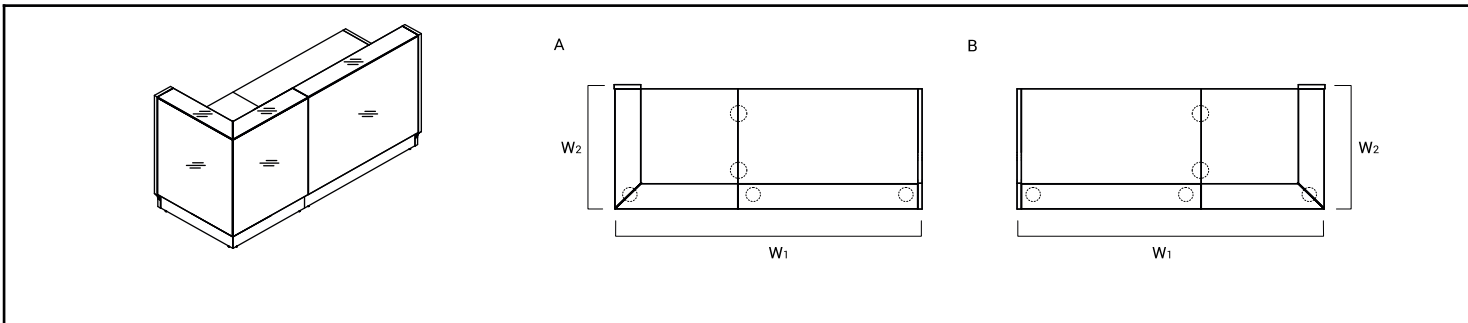

INDEX SYMBOL	DIMENSIONS [mm]					PRICE EUR				COMPONENTS
	W <sub>1</sub>	W <sub>2</sub>	D <sub>1</sub>	D <sub>2</sub>	H		kg	m <sup>3</sup>	pcs	
A <b>LIN38L</b>	2050	850	-	-	1105	3 365,-	178.0	1.560	10	LN5L+LNB13+LN12+LNB08+LN91 +LN3P+NL41
B <b>LIN38P</b>	2050	850	-	-	1105	3 365,-	178.0	1.560	10	LN3L+LNB08+LN91+LNB13+LN12 +LN5P+NL41

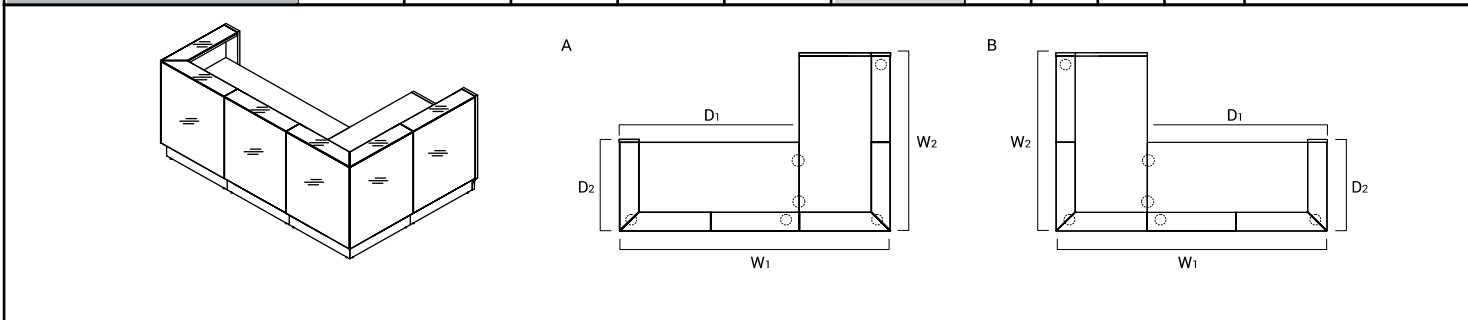

INDEX SYMBOL	DIMENSIONS [mm]					PRICE EUR				COMPONENTS
	W <sub>1</sub>	W <sub>2</sub>	D <sub>1</sub>	D <sub>2</sub>	H		kg	m <sup>3</sup>	pcs	
A <b>LIN39L</b>	2444	1650	1622	850	1105	5 660,-	286.0	2.735	14	LN5L+2xLN08+2xLNB15+2xLN91 +LN3P+NL41
B <b>LIN39P</b>	2444	1650	1622	850	1105	5 660,-	292.0	2.746	16	LN3L+2xLN91+2xLNB15+2xLN08 +LN5P+NL41

ADDITIONAL CHARGE

FEATURE	PRODUCT											COMMENTS
	LIN38L	LIN38P	LIN39L	LIN39P					kg	m <sup>3</sup>	pcs	
MONITOR SHELF x 1	160,-	160,-	160,-	160,-					0.1	0.0001	1	
MONITOR SHELF x 2			320,-	320,-					0.9	0.0070	1	

DESCRIPTION

- NET WEIGHT

VOLUME

NUMBER OF PACKAGES

RECEPTION DESKS SYSTEMS

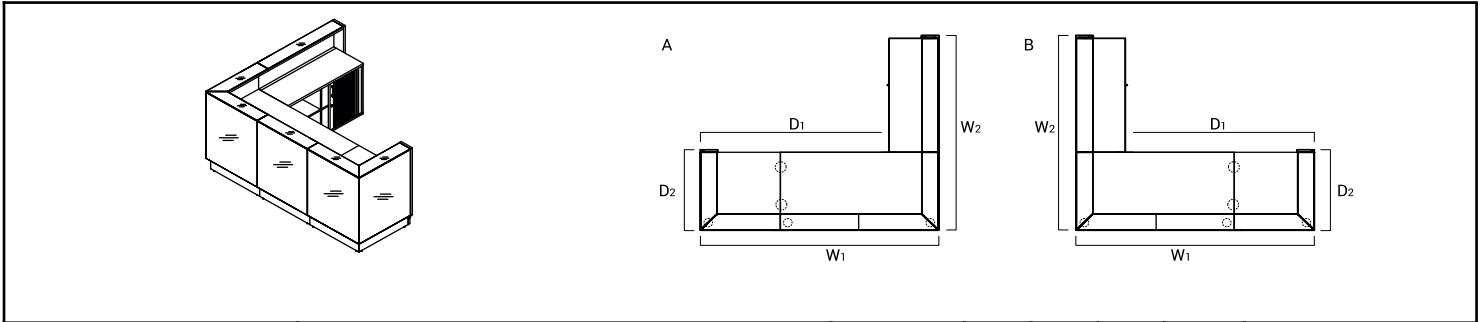

INDEX SYMBOL	DIMENSIONS [mm]					PRICE EUR				COMPONENTS
	W <sub>1</sub>	W <sub>2</sub>	D <sub>1</sub>	D <sub>2</sub>	H		kg	m <sup>3</sup>	pcs	
A <b>LIN40L</b>	2444	2050	1950	850	1105	6 345,-	332.5	3.283	16	LN3L+LN12+L2Z06+2xLN91+LNB15+LN08+LNB08+LN3P+NL41
B <b>LIN40P</b>	2444	2050	1950	850	1105	6 345,-	332.5	3.283	16	LN3L+LNB08+2xLN91+LN08+LNB15+L2Z06+LN12+LN3P+NL41

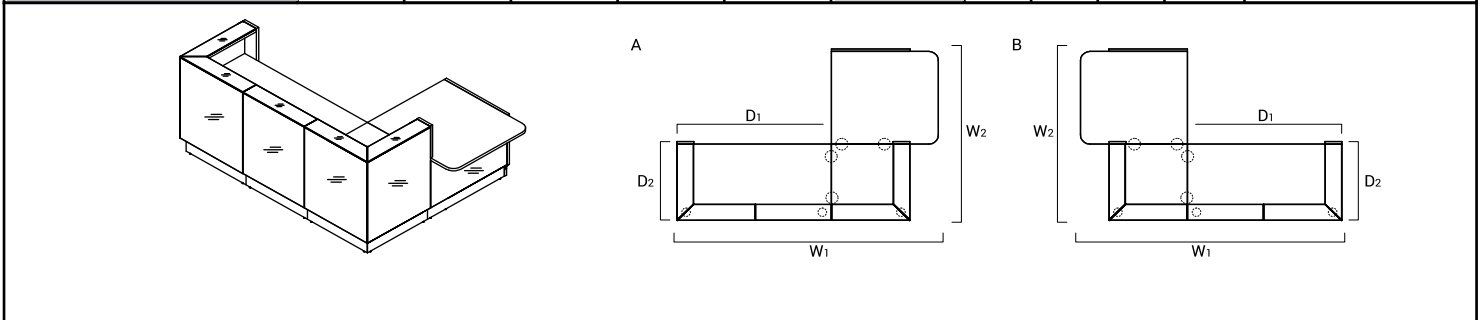

INDEX SYMBOL	DIMENSIONS [mm]					PRICE EUR				COMPONENTS
	W <sub>1</sub>	W <sub>2</sub>	D <sub>1</sub>	D <sub>2</sub>	H		kg	m <sup>3</sup>	pcs	
A <b>LIN41L</b>	2744	1850	1622	850	1105	5 610,-	282.5	2.674	16	LN6L+LNU11+LN4L+2xLN91+LNB08+LN08+LNB15+LN3P+2xNL41
B <b>LIN41P</b>	2744	1850	1622	850	1105	5 610,-	282.5	2.672	16	LN3L+2xLN91+LNB15+LN08+LNB08+LN4P+LNU11+LN6P+2xNL41
A <b>LIN411L</b>	2544	1850	1622	850	1105	5 515,-	277.5	2.648	16	LN6L+LNU11+LN4L+2xLN91+LNB08+LN08+LNB15+LN3P+2xNL41
B <b>LIN411P</b>	2544	1850	1622	850	1105	5 515,-	277.5	2.645	16	LN3L+2xLN91+LNB15+LN08+LNB08+LN4P+LNU11+LN6P+2xNL41

ADDITIONAL CHARGE



FEATURE	PRODUCT									COMMENTS
	LIN40L	LIN40P	LIN41L	LIN41P	LIN411L	LIN411P	kg	m <sup>3</sup>	pcs	
MONITOR SHELF x 1	160,-	160,-	160,-	160,-	160,-	160,-	0.1	0.0001	1	

DESCRIPTION





- NET WEIGHT

VOLUME

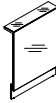

NUMBER OF PACKAGES

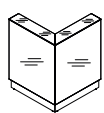
PRODUCT ILLUSTRATION	DIMENSIONS [mm]			INDEX SYMBOL	PRICE EUR				COMMENTS
	WIDTH	DEPTH	HEIGHT			kg	m3	pcs	

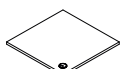
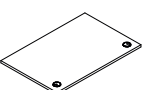
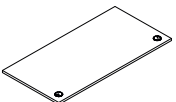
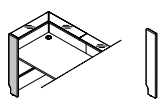
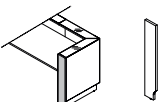
COMPOSITION ELEMENTS

	800	250	1105	<b>LN08</b>	1 040,-	27.5	0.254	2	
	1200	250	1105	<b>LN12</b>	1 420,-	41.5	0.376	2	
	822	822	1105	<b>LN91</b>	1 575,-	78.5	1.007	2	
	800	1122	740	<b>LNU111</b>	850,-	26.5	0.129	2	
	1000	1122	740	<b>LNU11</b>	945,-	31.5	0.156	2	
	800	800	28	<b>LNB08</b>	75,-	14.0	0.025	1	
	1200	800	28	<b>LNB13</b>	95,-	21.0	0.042	2	
	1600	800	28	<b>LNB15</b>	115,-	27.0	0.054	2	
	254	28	1105	<b>LN3L</b>	75,-	7.0	0.014	1	left
	254	28	1105	<b>LN3P</b>	75,-	7.0	0.014	1	right

ADDITIONAL CHARGE



FEATURE	PRODUCT									COMMENTS
					LNB13	LNB15	kg	m3	pcs	
MONITOR SHELF x 1					160,-	160,-	0.1	0.0001	1	

DESCRIPTION







 - NET WEIGHT

 VOLUME

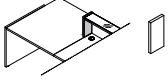
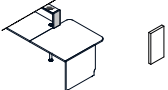
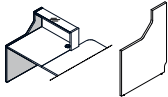
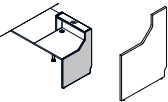
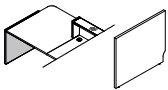
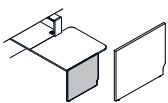
 NUMBER OF PACKAGES

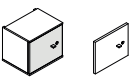
PRODUCT ILLUSTRATION	DIMENSIONS [mm]			INDEX SYMBOL	PRICE EUR				COMMENTS
	WIDTH	DEPTH	HEIGHT			kg	m3	pcs	

COMPOSITION ELEMENTS

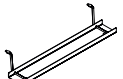
	254	28	367	<b>LN4L</b>	65,-	2.5	0.006	1	left
	254	28	367	<b>LN4P</b>	65,-	2.5	0.006	1	right
	824	28	1105	<b>LN5L</b>	95,-	14.0	0.033	1	left
	824	28	1105	<b>LN5P</b>	95,-	14.0	0.033	1	right
	824	28	740	<b>LN6L</b>	85,-	12.0	0.024	1	left
	824	28	740	<b>LN6P</b>	85,-	12.0	0.022	1	right
	345	283	314	<b>LMS05</b>	180,-	5.0	0.031	1	
	339	18	286	<b>LMS06</b>	60,-	2.0	0.005	1	
	1200	532	740	<b>L2Z06</b>	365,-	49.5	0.469	2	
	585	142	712	<b>NL41</b>	30,-	2.0	0.063	1	round profile leg
	580	162	123	<b>S69L</b>	25,-	1.0	0.015	1	09 - aluminum
	460	89	120	<b>E64L</b>	32,-	0.5	0.001	1	horizontal cable tray M009 - aluminum semi - matte

DESCRIPTION

 - NET WEIGHT

 VOLUME

 NUMBER OF PACKAGES





## TECHNICAL SPECIFICATION

### COLOURS

---

#### COUNTER TOP - GLASS

---



WHITE, TEMPERED  
GLASS

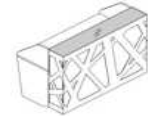

---

#### BODY

---



67 WHITE PASTEL

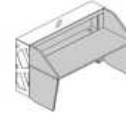

---

#### FRONT - METAL

---



M015 WHITE  
SEMI-MATTE



---

#### FRONT - PLEXIGLASS

---



PLEXIGLASS  
WHITE



TECHNICAL SPECIFICATION

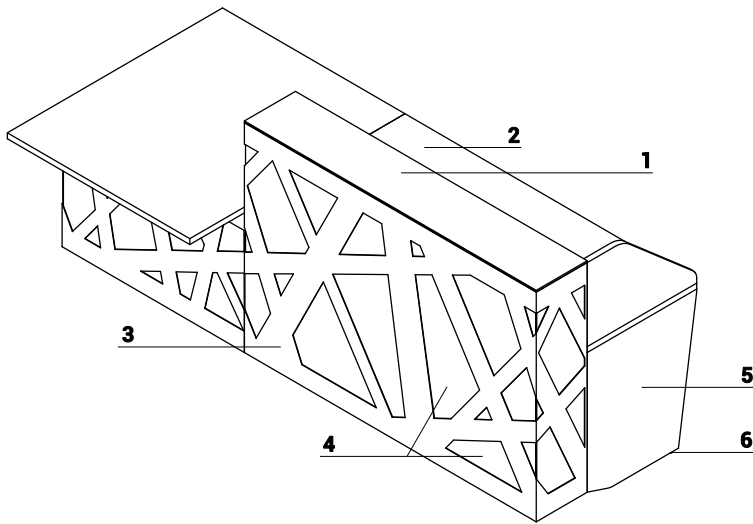

- 1. **Top** - tempered optiwhite glass, 8mm - painted on bottom side
- 2. **Worktop** - MFC 28mm, PVC edge
- 3. **Front** - powder coated steel and plexiglas
- 4. **Light source** - RGBW LED, remote control
- 5. **Low side panel** - MFC 28mm, PVC edge
- 6. **Leveling** - 5mm range

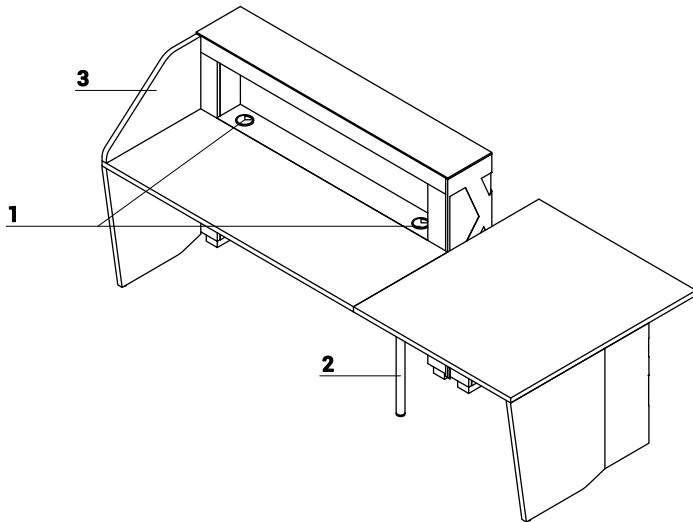

- 1. **Cable grommets** - Ø80mm
- 2. **Supporting leg NE41**- required for connecting the tops
- 3. **Side panel** - MFC 28mm, PVC edge

DIMENSIONS

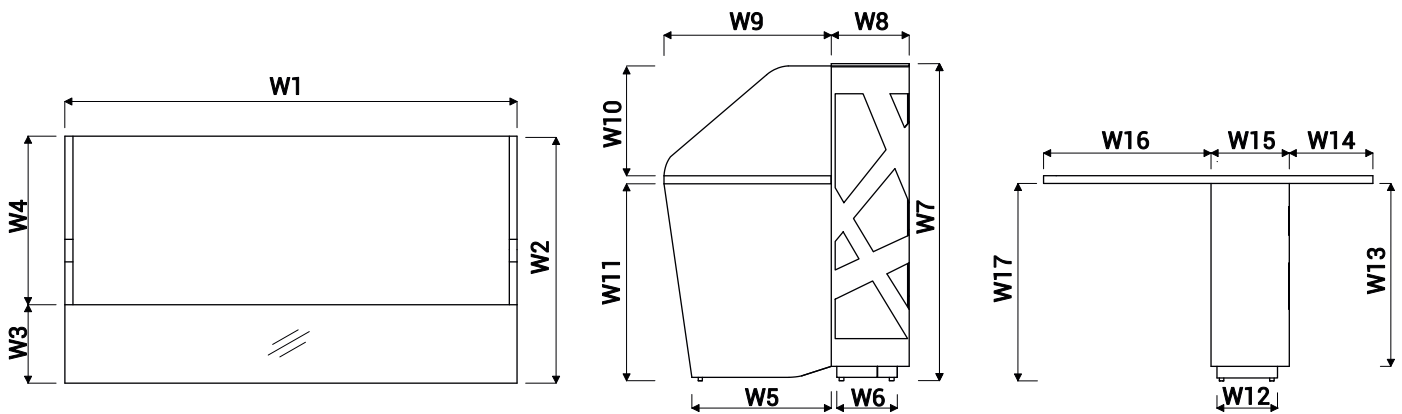

W1 - 1600mm | W2 - 880mm | W3 - 280mm | W4 - 600mm | W5 - 500mm | W6 - 217mm | W7 - 1146mm | W8 - 280mm | W9 - 600mm | W10 - 397mm | W11 - 712mm | W12 - 217mm | W13 - 660mm | W14 - 300mm | W15 - 280mm | W16 - 600mm | W17 - 712mm

RECEPTION DESKS SYSTEMS

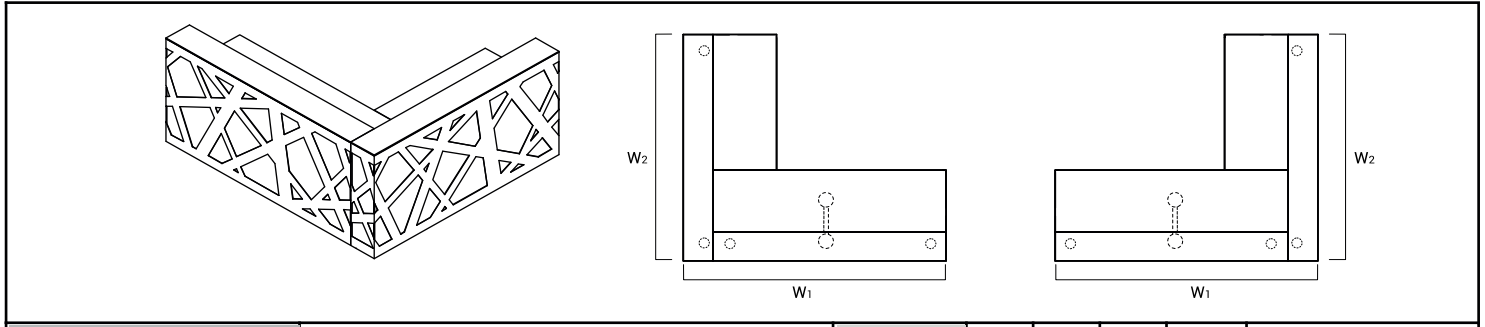

INDEX SYMBOL	DIMENSIONS [mm]					PRICE EUR				COMPONENTS
	W <sub>1</sub>	W <sub>2</sub>	D <sub>1</sub>	D <sub>2</sub>	H		kg	m <sup>3</sup>	pcs	
<b>LZG44</b>	2480	2200	-	-	1146	8 580,-	276.2	3.224	14	LZN51+LZB22+2xLZG22+LZB22M+NL41

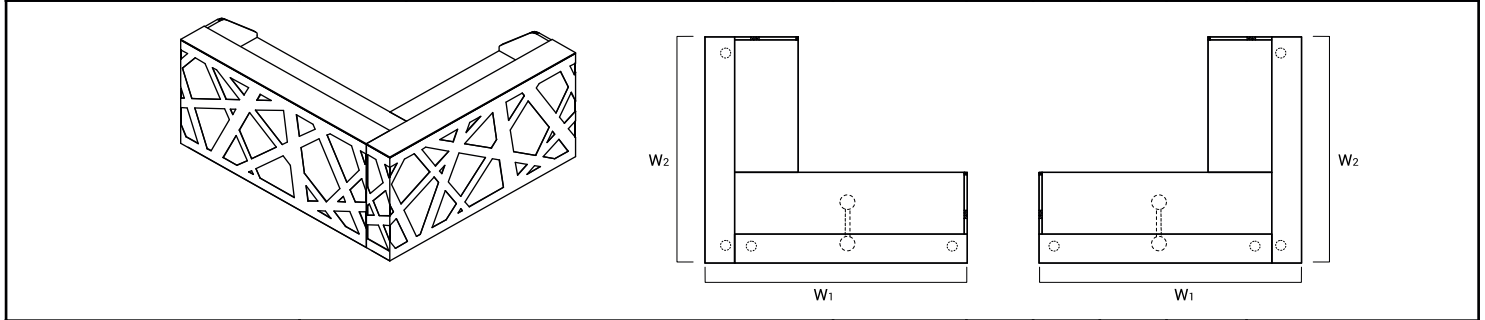

INDEX SYMBOL	DIMENSIONS [mm]					PRICE EUR				COMPONENTS
	W <sub>1</sub>	W <sub>2</sub>	D <sub>1</sub>	D <sub>2</sub>	H		kg	m <sup>3</sup>	pcs	
<b>LZG45</b>	2480	2200	-	-	1146	8 655,-	283.2	3.243	15	LZN51+LZK01+2xLZG22+LZB22+LZB22M+NL41



INDEX SYMBOL	DIMENSIONS [mm]					PRICE EUR				COMPONENTS
	W <sub>1</sub>	W <sub>2</sub>	D <sub>1</sub>	D <sub>2</sub>	H		kg	m <sup>3</sup>	pcs	
<b>LZG34</b>	1600	880	-	-	1146	3 470,-	126.9	1.245	7	LZN51+LZK01+LZG16+LZB16
<b>LZG46</b>	2200	880	-	-	1146	4 415,-	156.9	1.690	8	LZN51+LZK01+LZG22+LZB22

DESCRIPTION

- NET WEIGHT

VOLUME

NUMBER OF PACKAGES

RECEPTION DESKS SYSTEMS

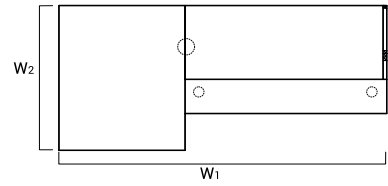
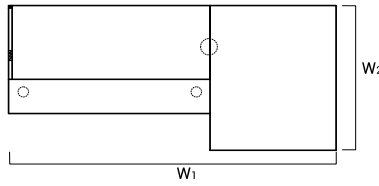
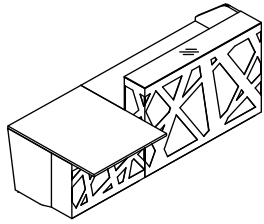

INDEX SYMBOL	DIMENSIONS [mm]					PRICE EUR				COMPONENTS
	W <sub>1</sub>	W <sub>2</sub>	D <sub>1</sub>	D <sub>2</sub>	H		kg	m <sup>3</sup>	pcs	
<b>LZG50</b>	2600	1180	-	-	1146	5 520,-	208.4	1.798	11	LZN51+LZG10+LZG16+LZB16 +LZK01+NE41L
<b>LZG51</b>	3200	1180	-	-	1146	6 465,-	238.4	2.242	12	LZN51+LZG10+LZG22+LZB22 +LZK01+NE41L

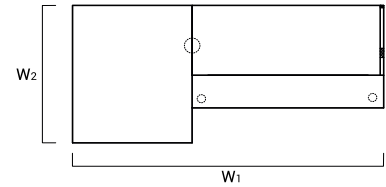
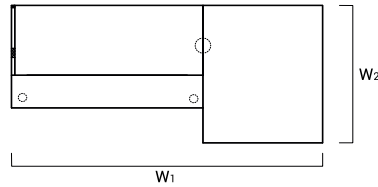
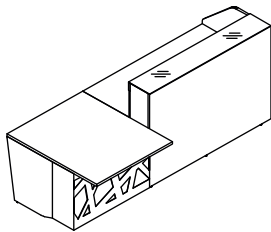

INDEX SYMBOL	DIMENSIONS [mm]					PRICE EUR				COMPONENTS
	W <sub>1</sub>	W <sub>2</sub>	D <sub>1</sub>	D <sub>2</sub>	H		kg	m <sup>3</sup>	pcs	
<b>LZG56</b>	2600	1180	-	-	1146	3 235,-	210.4	1.798	11	LZG10+LZG16M+LZB16+LZN51 +LZK01+NE41L

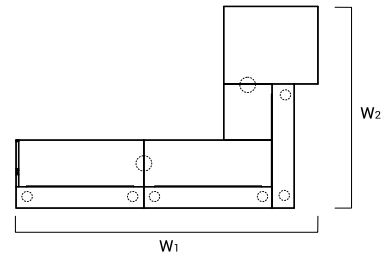
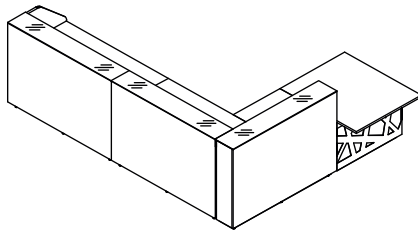

INDEX SYMBOL	DIMENSIONS [mm]					PRICE EUR				COMPONENTS
	W <sub>1</sub>	W <sub>2</sub>	D <sub>1</sub>	D <sub>2</sub>	H		kg	m <sup>3</sup>	pcs	
<b>LZG57</b>	3200	2880	-	-	1146	5 270,-	419.2	4.153	23	LZN51+LZG10+LZB16M+2xLZB16 +3xLZG16M+LZK01+2xNE41L

DESCRIPTION

- NET WEIGHT

VOLUME

NUMBER OF PACKAGES

RECEPTION DESKS SYSTEMS

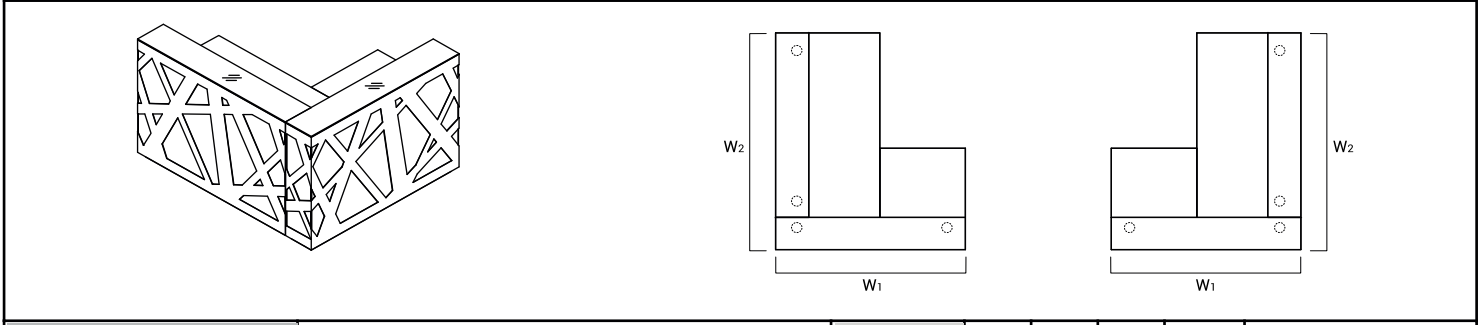

INDEX SYMBOL	DIMENSIONS [mm]					PRICE EUR				COMPONENTS
	W <sub>1</sub>	W <sub>2</sub>	D <sub>1</sub>	D <sub>2</sub>	H		kg	m <sup>3</sup>	pcs	
<b>LZG32</b>	1600	1880	-	-	1146	6 660,-	217.5	2.386	12	LZB16M+2xLZG16+LZB16+LZN51

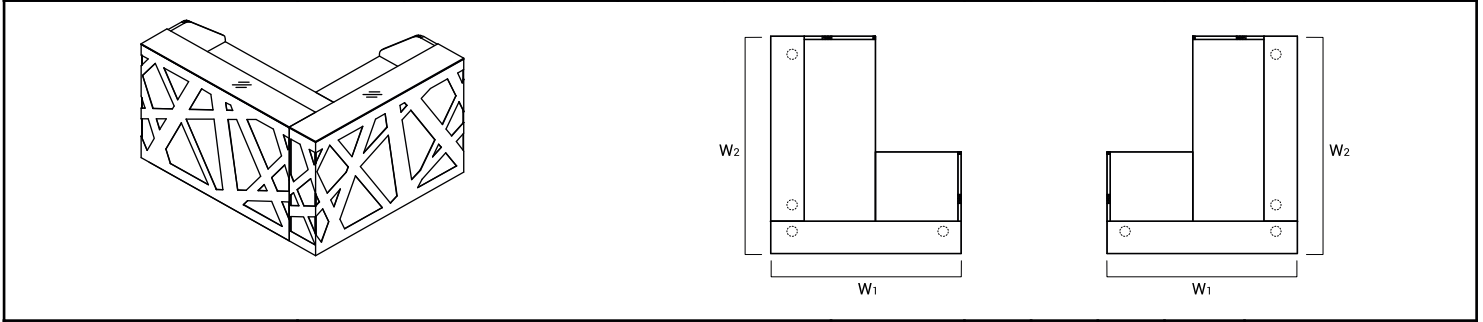

INDEX SYMBOL	DIMENSIONS [mm]					PRICE EUR				COMPONENTS
	W <sub>1</sub>	W <sub>2</sub>	D <sub>1</sub>	D <sub>2</sub>	H		kg	m <sup>3</sup>	pcs	
<b>LZG35</b>	1600	1880	-	-	1146	6 735,-	224.5	2.405	13	LZB16M+2xLZG16+LZB16+LZN51+LZK01

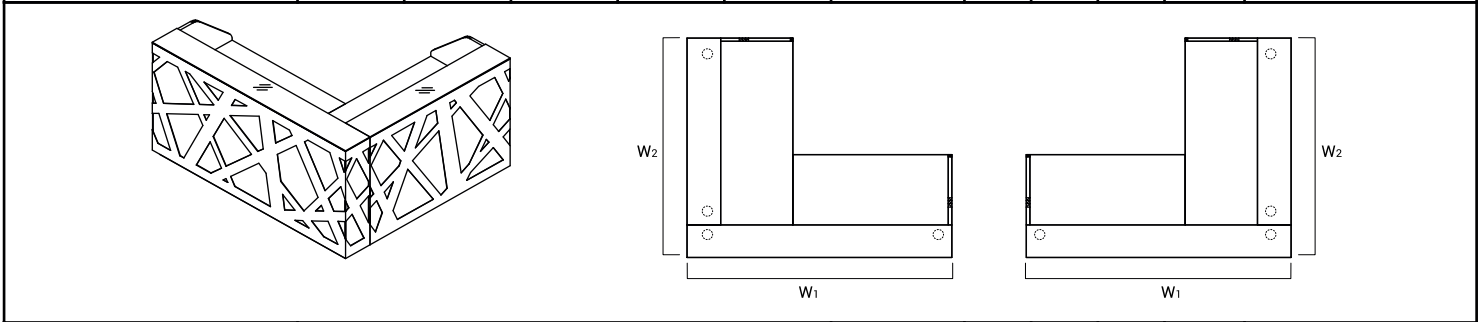

INDEX SYMBOL	DIMENSIONS [mm]					PRICE EUR				COMPONENTS
	W <sub>1</sub>	W <sub>2</sub>	D <sub>1</sub>	D <sub>2</sub>	H		kg	m <sup>3</sup>	pcs	
<b>LZG36</b>	2200	1880	-	-	1146	7 680,-	252.5	2.799	13	LZN51+LZK01+LZB22+LZG22+LZB16M+LZG16

DESCRIPTION

- NET WEIGHT

VOLUME

NUMBER OF PACKAGES

RECEPTION DESKS SYSTEMS

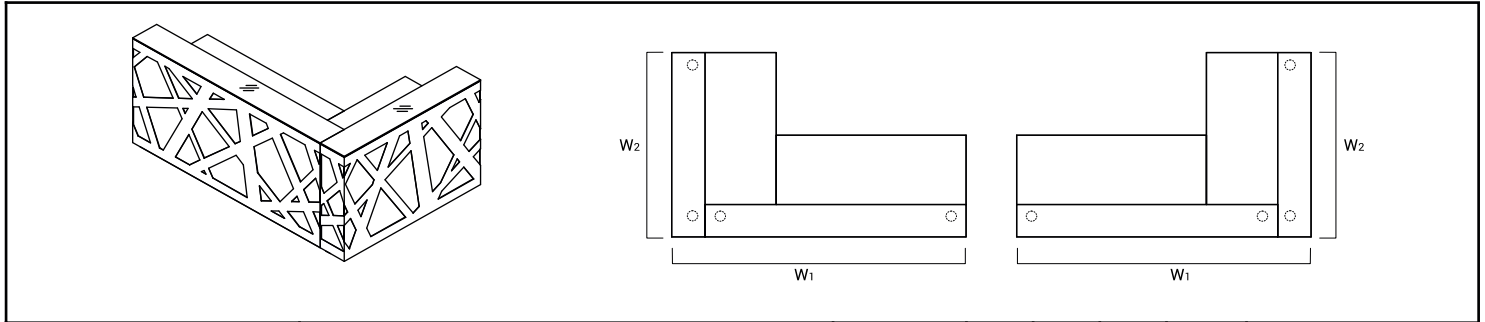

INDEX SYMBOL	DIMENSIONS [mm]					PRICE EUR				COMPONENTS
	W <sub>1</sub>	W <sub>2</sub>	D <sub>1</sub>	D <sub>2</sub>	H		kg	m <sup>3</sup>	pcs	
<b>LZG38</b>	2480	1600	-	-	1146	7 605,-	245.5	2.779	12	LZN51+LZB16+LZG22+LZB22M+LZG16

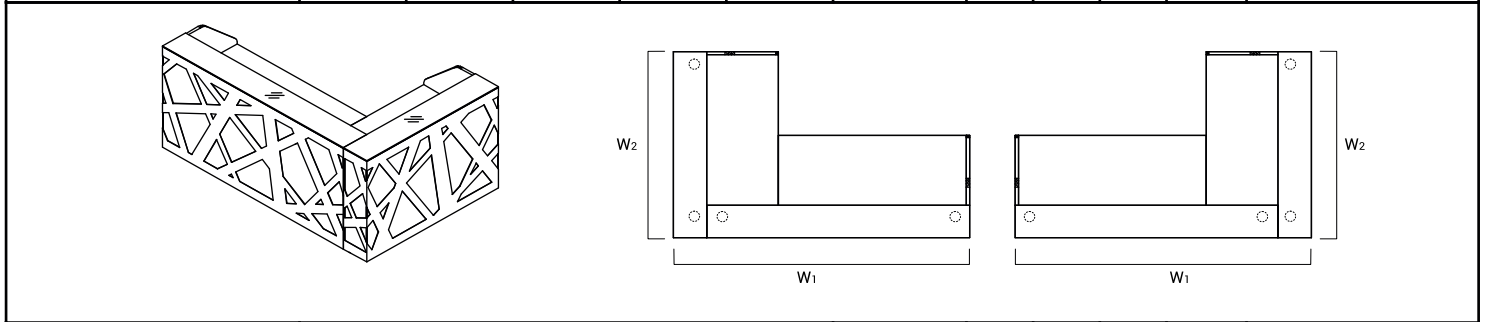

INDEX SYMBOL	DIMENSIONS [mm]					PRICE EUR				COMPONENTS
	W <sub>1</sub>	W <sub>2</sub>	D <sub>1</sub>	D <sub>2</sub>	H		kg	m <sup>3</sup>	pcs	
<b>LZG40</b>	2480	1600	-	-	1146	7 680,-	252.5	2.799	13	LZN51+LZK01+LZB16+LZG22+LZB22M+LZG16

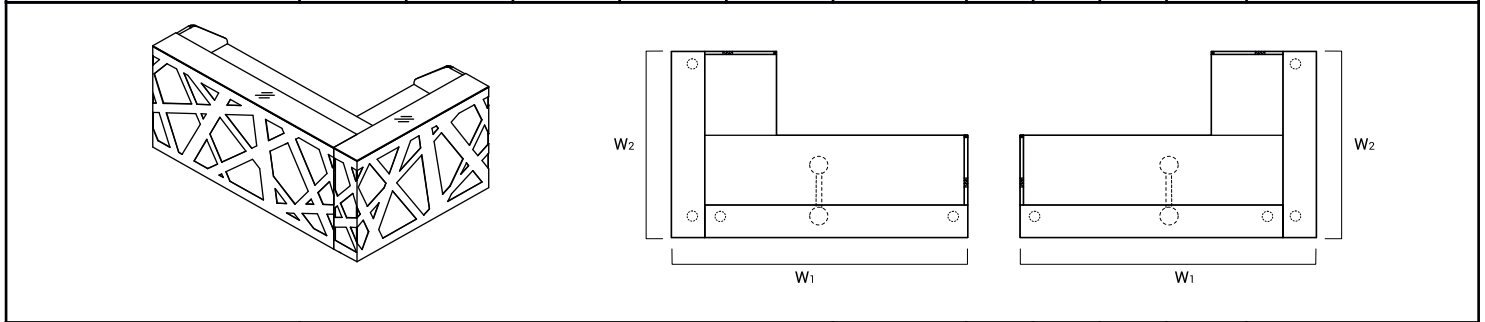

INDEX SYMBOL	DIMENSIONS [mm]					PRICE EUR				COMPONENTS
	W <sub>1</sub>	W <sub>2</sub>	D <sub>1</sub>	D <sub>2</sub>	H		kg	m <sup>3</sup>	pcs	
<b>LZG42</b>	2480	1600	-	-	1146	7 710,-	252.4	2.849	11	LZN51+LZK01+LZB22+LZG22+LZB16M+LZG16+NL41

DESCRIPTION

- NET WEIGHT

VOLUME

NUMBER OF PACKAGES

RECEPTION DESKS SYSTEMS

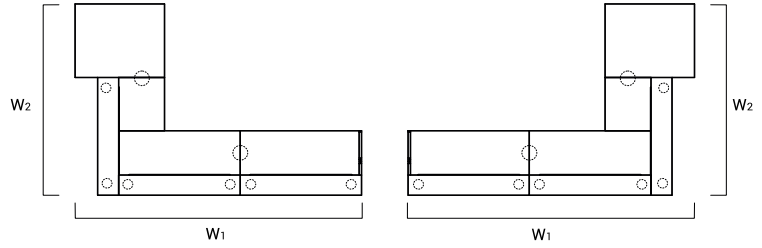
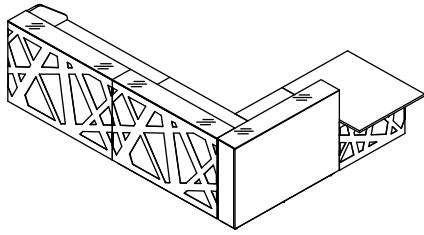

INDEX SYMBOL	DIMENSIONS [mm]					PRICE EUR				COMPONENTS
	W <sub>1</sub>	W <sub>2</sub>	D <sub>1</sub>	D <sub>2</sub>	H		kg	m <sup>3</sup>	pcs	
LZG58	3808	2880	-	-	1146	9 840,-	415.2	4.153	23	LZN51+LZK01+2xLZB16+2xLZG16 +LZG16M+LZB16M+LZG10N +2xNE41L

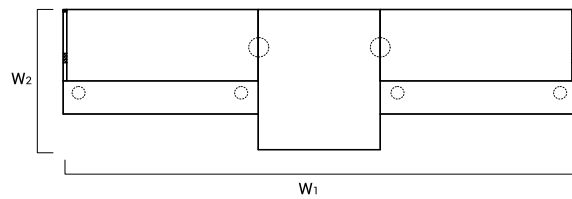
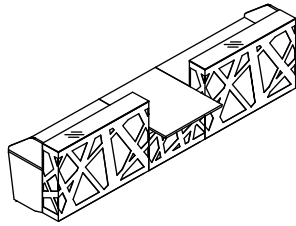

INDEX SYMBOL	DIMENSIONS [mm]					PRICE EUR				COMPONENTS
	W <sub>1</sub>	W <sub>2</sub>	D <sub>1</sub>	D <sub>2</sub>	H		kg	m <sup>3</sup>	pcs	
LZG52	4200	1180	-	-	1146	8 860,-	314.8	2.991	17	LZN51+LZK01+LZB16+LZG16 +LZG10+LZG16+LZB16+2xNE41L
LZG53	4800	1180	-	-	1146	9 805,-	344.8	3.435	18	LZN51+LZK01+LZB16+LZG16 +LZG10+LZG22+LZB22+2xNE41L
LZG54	5400	1180	-	-	1146	10 750,-	374.8	3.880	19	LZN51+LZK01+LZB22+LZG22 +LZG10+LZG22+LZB22+2xNE41L

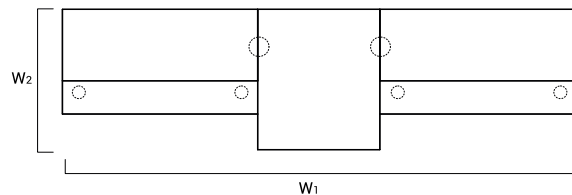
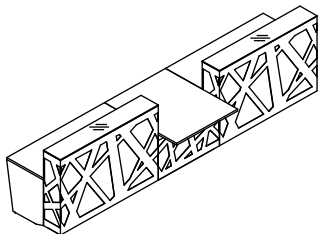

INDEX SYMBOL	DIMENSIONS [mm]					PRICE EUR				COMPONENTS
	W <sub>1</sub>	W <sub>2</sub>	D <sub>1</sub>	D <sub>2</sub>	H		kg	m <sup>3</sup>	pcs	
LZG55	4200	1180	-	-	1146	8 785,-	307.8	2.971	16	LZN51+LZB16+2xLZG16+LZG10 +LZB16+2xNE41L

DESCRIPTION

- NET WEIGHT

VOLUME

NUMBER OF PACKAGES



RECEPTION DESKS SYSTEMS

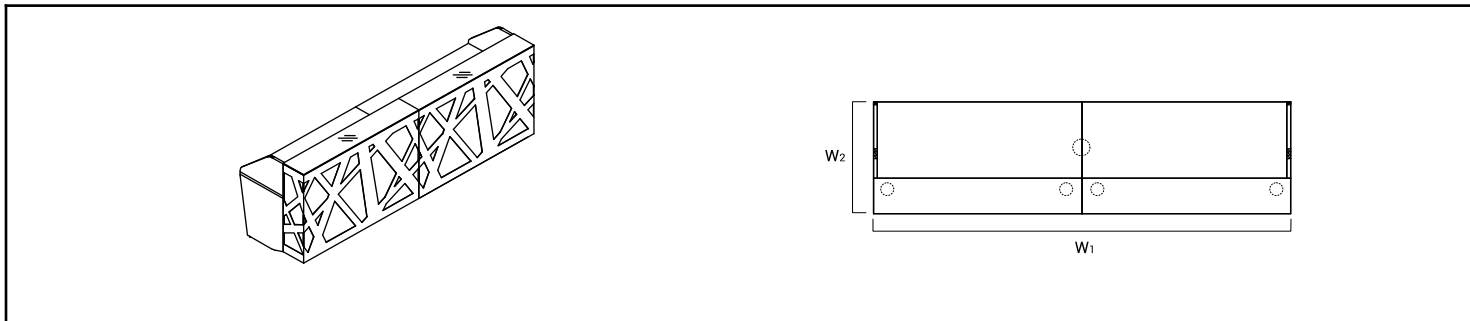

INDEX SYMBOL	DIMENSIONS [mm]					PRICE EUR				COMPONENTS
	W <sub>1</sub>	W <sub>2</sub>	D <sub>1</sub>	D <sub>2</sub>	H		kg	m <sup>3</sup>	pcs	
LZG60	3200	880	-	-	1146	6 810,-	233.3	2.438	13	LZN51+LZK01+LZB16+LZG16 +LZB16+LZG16+NE41L
LZG61	3800	880	-	-	1146	7 755,-	263.3	2.882	14	LZN51+LZK01+LZB16+LZG16 +LZB22+LZG22+NE41L
LZG62	4400	880	-	-	1146	8 700,-	293.3	3.327	15	LZN51+LZK01+LZB22+LZG22 +LZB22+LZG22+NE41L

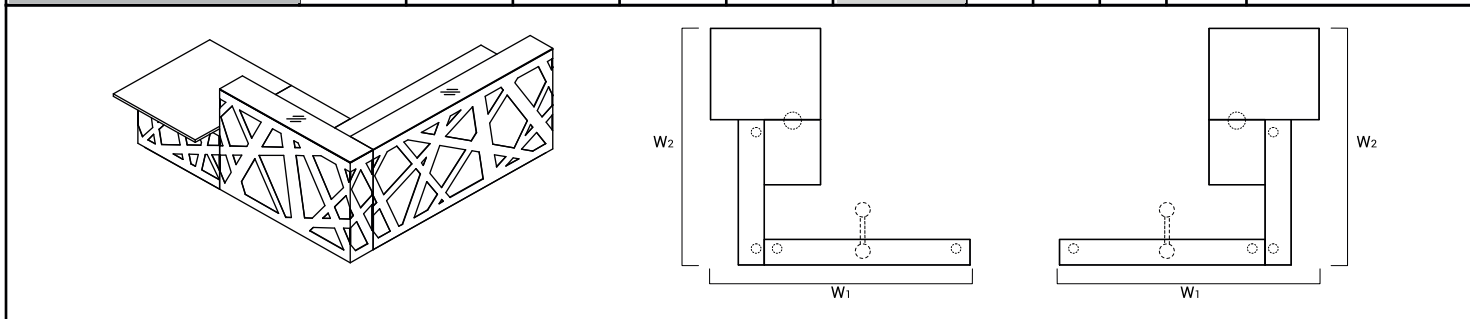

INDEX SYMBOL	DIMENSIONS [mm]					PRICE EUR				COMPONENTS
	W <sub>1</sub>	W <sub>2</sub>	D <sub>1</sub>	D <sub>2</sub>	H		kg	m <sup>3</sup>	pcs	
LZG64	2600	2780	-	-	1146	9 685,-	328.3	3.383	16	LZN51+LZB22+LZG22+LZG16 +LZB16M+LZG10+NL41+NE41L

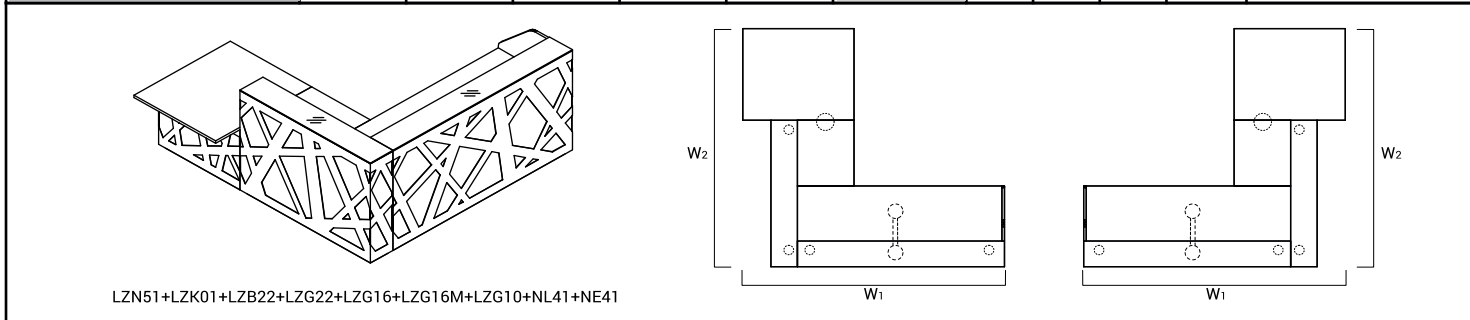

LZN51+LZK01+LZB22+LZG22+LZG16+LZG16M+LZG10+NL41+NE41



INDEX SYMBOL	DIMENSIONS [mm]					PRICE EUR				COMPONENTS
	W <sub>1</sub>	W <sub>2</sub>	D <sub>1</sub>	D <sub>2</sub>	H		kg	m <sup>3</sup>	pcs	
LZG63	2600	2780	-	-	1146	10 650,-	335.3	3.402	17	LZN51+LZK01+LZB22+LZG22 +LZG16+LZG16M+LZG10+NL41 +NE41L

DESCRIPTION









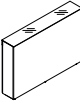

- NET WEIGHT

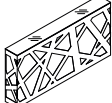
VOLUME

NUMBER OF PACKAGES

PRODUCT ILLUSTRATION	DIMENSIONS [mm]			INDEX SYMBOL	PRICE EUR					COMMENTS
	WIDTH	DEPTH	HEIGHT			kg	m3	pcs		

## COMPOSITION ELEMENTS



	1600	280	1146	<b>LZG16M</b>	935,-	88.5	1.143	2		
	1600	280	1146	<b>LZG16</b>	3 220,-	86.5	1.143	2		
	2200	280	1146	<b>LZG22</b>	4 135,-	107.5	1.523	2		
	1000	1180	740	<b>LZG10</b>	2 020,-	80.0	0.551	3		
	720	600	28	<b>LZB16M</b>	45,-	10.4	0.017	3		
	1320	600	28	<b>LZB22M</b>	75,-	18.1	0.031	4		
	1600	600	28	<b>LZB16</b>	90,-	18.4	0.049	3		
	2200	600	28	<b>LZB22</b>	120,-	25.4	0.050	3		use of support leg NL41 in the middle of worktop advisable!
	600	28	397	<b>LZK01</b>	75,-	7.0	0.020	1		
	600	28	712	<b>LZN51</b>	85,-	15.0	0.035	1		
	40	40	712	<b>NE41L</b>	30,-	1.5	0.002	1		round profile leg

DESCRIPTION



 - NET WEIGHT

 VOLUME

 NUMBER OF PACKAGES

PRODUCT ILLUSTRATION	DIMENSIONS [mm]			INDEX SYMBOL	PRICE EUR				COMMENTS
	WIDTH	DEPTH	HEIGHT			kg	m3	pcs	

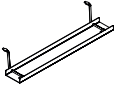
## COMPOSITION ELEMENTS

	585	142	712	<b>NL41</b>	30,-	2.0	0.063	1	round profile leg
	460	89	120	<b>E64L</b>	32,-	0.5	0.001	1	horizontal cable tray M009 - aluminum semi - matte
	580	162	123	<b>S69L</b>	25,-	1.0	0.015	1	09 - aluminum

DESCRIPTION

 - NET WEIGHT

 VOLUME

 NUMBER OF PACKAGES

TECHNICAL SPECIFICATION

COLOURS

COUNTER TOP, WORKTOP



26 ALUMINUM SATINATO



GLASS LACOBEL, SILVER



67 WHITE PASTEL

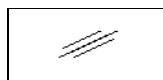

WHITE, LACOBEL



FRONT HPL



31 CANADIAN OAK



34 CHESTNUT



73 HIGH GLOSS WHITE



74 HIGH GLOSS ORANGE



80 HIGH GLOSS LIME



81 HIGH GLOSS BURGUNDY



102 HIGH GLOSS YELLOW



108 BLUE HIGH GLOSS



127 HIGH GLOSS FUCHSIA



148 HIGH GLOSS GRAY



INTERIOR



67 WHITE PASTEL



HPL ELEMENTS STRUCTURE

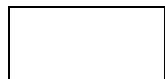

73 HIGH GLOSS WHITE



148 HIGH GLOSS GRAY

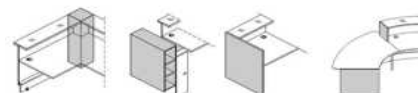

FRONT LAD10



26 ALUMINUM SATINATO

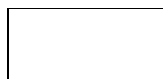

67 WHITE PASTEL



SUPPORTING LEG WHERE WORKTOPS CONNECT NL41



M009 ALUMINUM SEMI-MATTE



M015 WHITE SEMI-MATTE



STACK-ON WORKTOP STORAGE FOR RECEPTION DESK



26 ALUMINUM SATINATO



67 WHITE PASTEL



## TECHNICAL SPECIFICATION

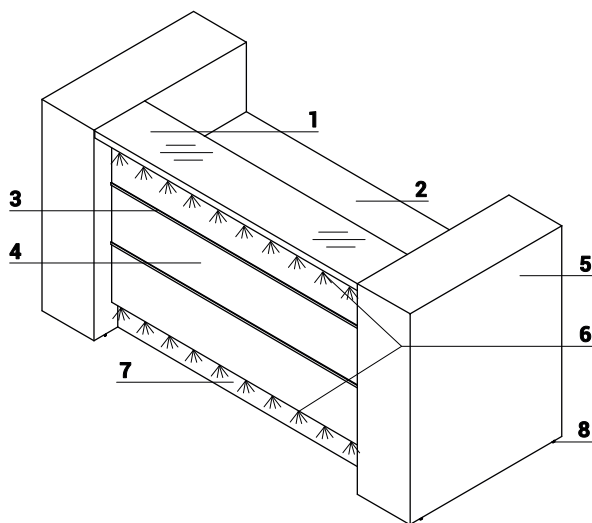

1. **Top** - MFC 36mm + Glass LACOBEL 4mm (40mm)
2. **Worktop** - MFC 28mm, PVC edge
3. **Decorative stripe** - PVC, colour: M009 - aluminum semi-matte
4. **Front** - HPL 3mm - high gloss
5. **Storage as ending element** - HPL high gloss 18mm, PVC edge
6. **LED illumination** - at the full length of the reception desk, cold white colour (verging on the blue shade)
7. **Kick plate** - HPL - brushed aluminum
8. **Leveling** - 5mm range

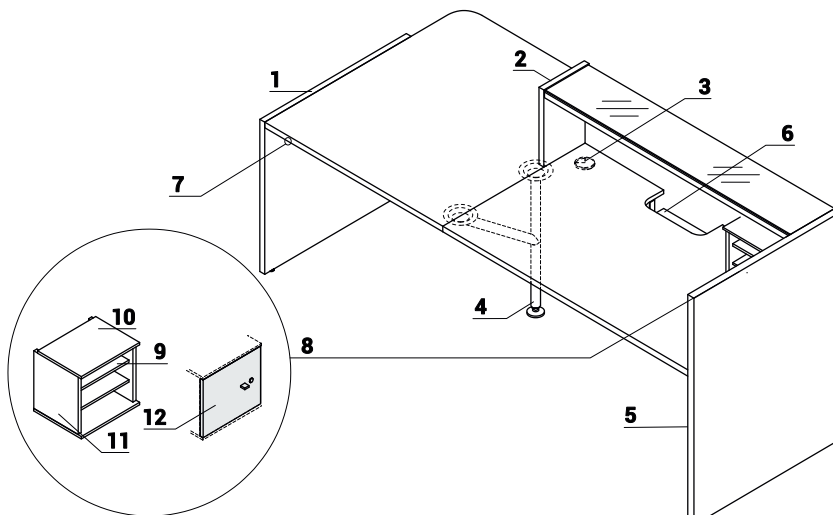

1. **Low side panel** - HPL high gloss - 38mm
2. **Side panel linking low and high fronts** - HPL high gloss - 38mm
3. **Cable grommets** - Ø80mm
4. **Supporting leg NE41** - made of metal, required for tops connecting, colours: M015 - white semi-mat, M009 - Aluminium semi-matt, colour adjusted to the colour of worktop
5. **High side panel** - HPL high gloss - 38mm
6. **Option with additional charge** - working top with lowered monitor shelf - MFC 28mm, PVC edge
7. **Light switch**
8. **LMS05** - reception desk storage; order separately
9. **Shelf** - MFC 18mm, PVC edge
10. **Top** - MFC 12mm, PVC edge
11. **Body** - MFC 18mm, PVC edge
12. **Optional front with lock** - universal (left, right) - MFC 18mm, PVC edge; - ordered as separate element

ATTENTION - Interior of the front in white

## ENDING STORAGE

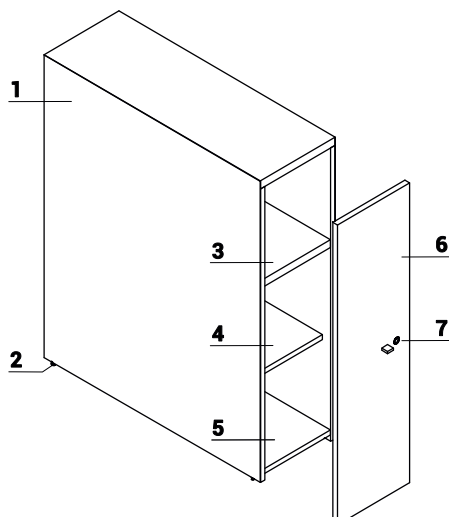

1. **Storage as ending element** - HPL high gloss 18mm, PVC edge
2. **Leveling** - 5mm range
3. **Shelf** - MFC 28mm, PVC edge
4. **Shelf with possibility of height regulation** - MFC 18mm, PVC edge
5. **Base** - MFC 18mm, PVC edge
6. **Optional Front LAD10** - MFC 18mm, universal (left/right), to order as an additional element
7. **Patent lock** - foldable key

**TECHNICAL SPECIFICATION**  
**ENDING ELEMENTS APPLICATION**

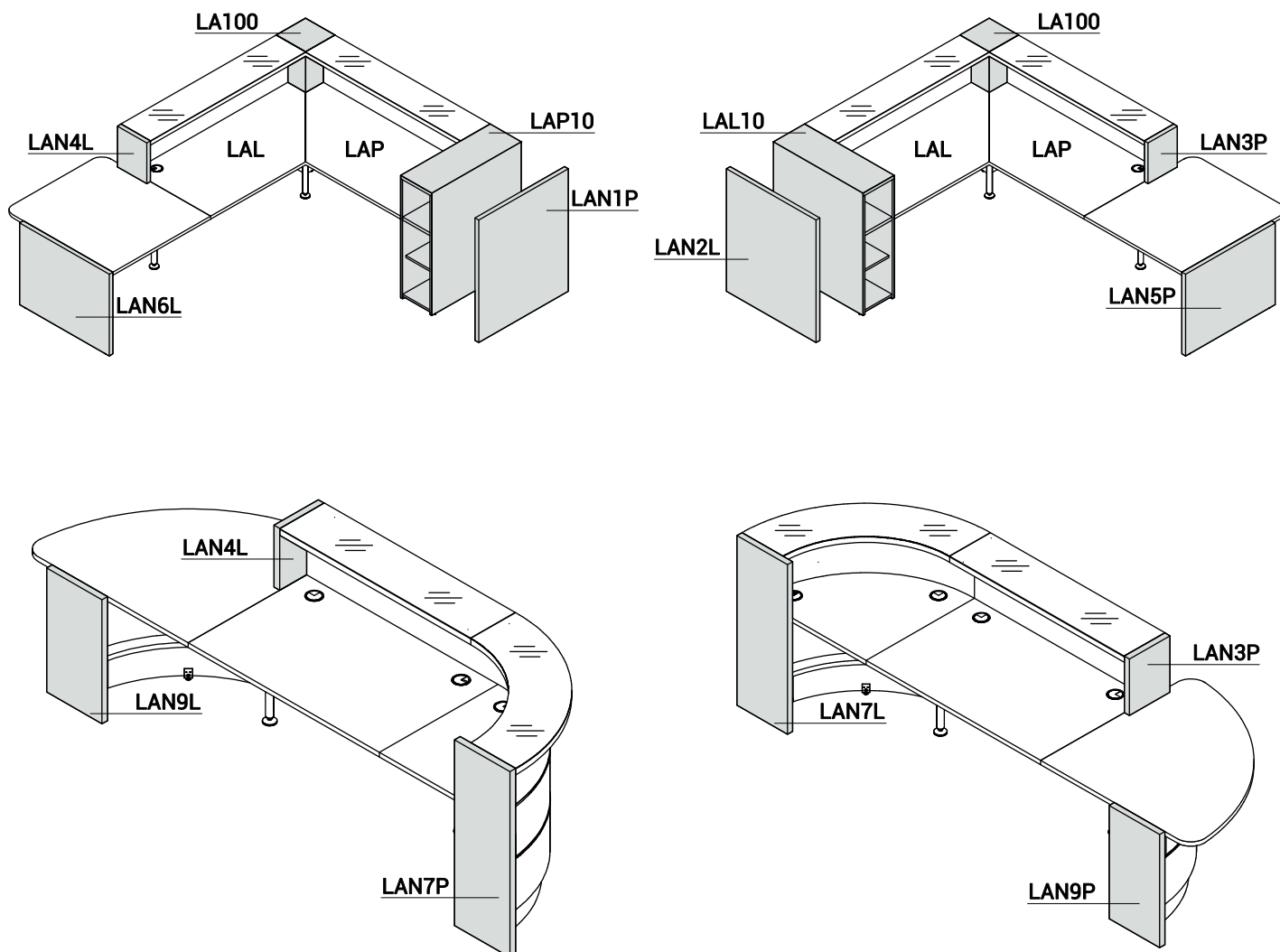

**DIMENSIONS**

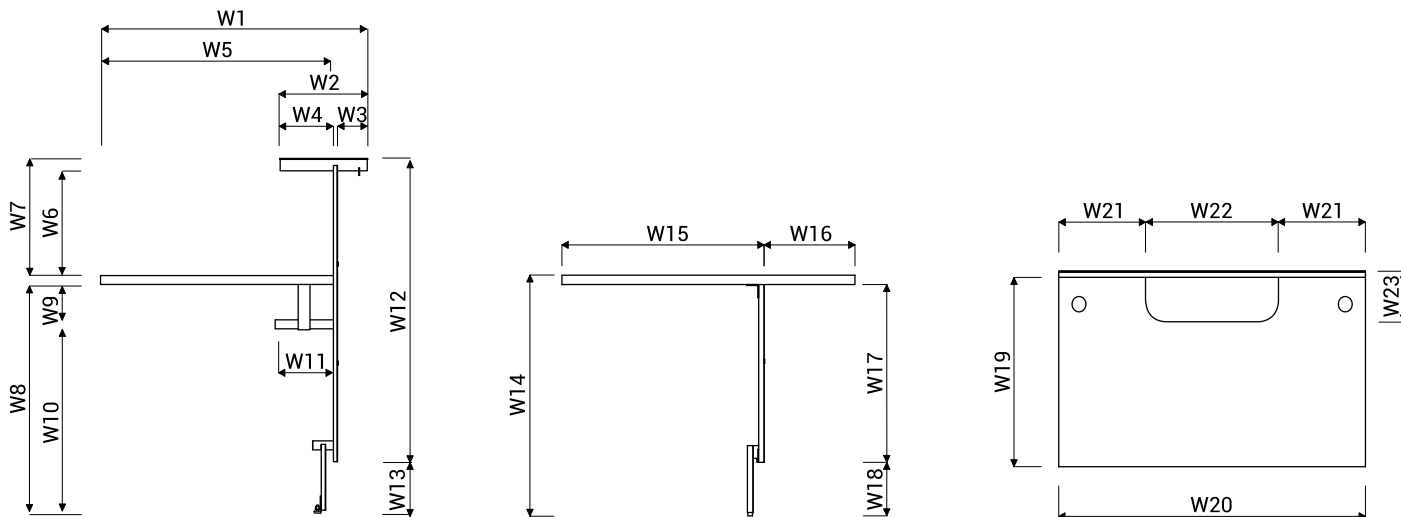

W1 - 916mm | W2 - 300mm | W3 - 103mm | W4 - 183mm | W5 - 800mm | W6 - 324mm | W7 - 364mm | W8 - 712mm | W9 - 110mm | W10 - 574mm |  
 W11 - 200mm | W12 - 944mm | W13 - 150mm | W14 - 740mm | W15 - 814mm | W16 - 300mm | W17 - 580mm | W18 - 160mm | W19 - 800mm | W20 -  
 1290/1590/2290mm | W21 - 385/535/885mm | W22 - 520mm | W23 - 200mm

RECEPTION DESKS SYSTEMS

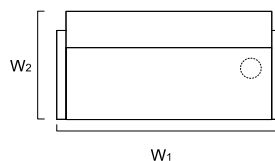
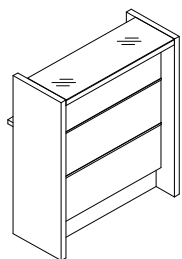

INDEX SYMBOL	DIMENSIONS [mm]					PRICE EUR				COMPONENTS
	W <sub>1</sub>	W <sub>2</sub>	D <sub>1</sub>	D <sub>2</sub>	H		kg	m <sup>3</sup>	pcs	
LAV96L	920	454	-	-	1105	1 335,-	50.5	0.178	5	LAN8L+LA09L+LAN7P

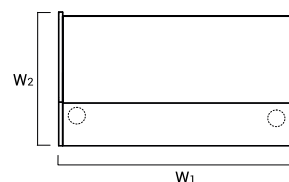
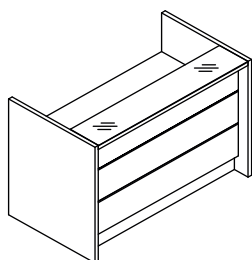

INDEX SYMBOL	DIMENSIONS [mm]					PRICE EUR				COMPONENTS
	W <sub>1</sub>	W <sub>2</sub>	D <sub>1</sub>	D <sub>2</sub>	H		kg	m <sup>3</sup>	pcs	
LAV95L	920	917	-	-	1105	1 525,-	88.0	0.252	6	LAN2L+LA09L+LAN1P
LAV75L	1366	917	-	-	1105	1 820,-	105.6	0.326	6	LAN2L+LA13L+LAN1P
LAV76L	1666	917	-	-	1105	2 050,-	119.0	0.373	6	LAN2L+LA16L+LAN1P
LAV77L	2366	917	-	-	1105	2 605,-	145.5	0.497	7	LAN2L+LA23L+LAN1P

ADDITIONAL CHARGE

FEATURE	PRODUCT											COMMENTS
		LAV75L	LAV76L	LAV77L					kg	m <sup>3</sup>	pcs	
MONITOR SHELF x 1		160,-	160,-	160,-					0.1	0.0001	1	

DESCRIPTION

- NET WEIGHT

VOLUME

NUMBER OF PACKAGES

RECEPTION DESKS SYSTEMS

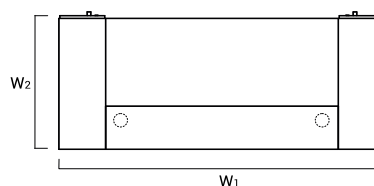
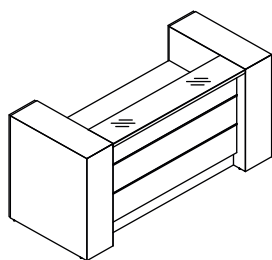

INDEX SYMBOL	DIMENSIONS [mm]					PRICE EUR				COMPONENTS
	W <sub>1</sub>	W <sub>2</sub>	D <sub>1</sub>	D <sub>2</sub>	H		kg	m <sup>3</sup>	pcs	
LAV01L	1926	937	-	-	1105	2 580,-	162.6	0.973	8	LAD10+LAL10+LA13L+LAP10+LAD10
LAV02L	2226	937	-	-	1105	2 810,-	176.0	1.020	8	LAD10+LAL10+LA16L+LAP10+LAD10
LAV03L	2926	937	-	-	1105	3 365,-	202.5	1.145	9	LAD10+LAL10+LA23L+LAP10+LAD10

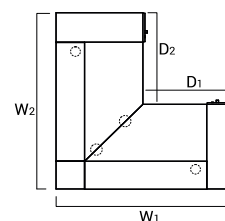
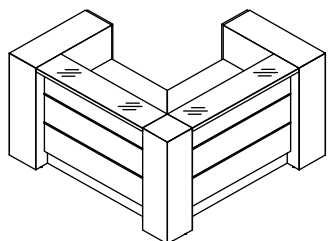

INDEX SYMBOL	DIMENSIONS [mm]					PRICE EUR				COMPONENTS
	W <sub>1</sub>	W <sub>2</sub>	D <sub>1</sub>	D <sub>2</sub>	H		kg	m <sup>3</sup>	pcs	
LAV10L	1908	1908	991	991	1105	4 295,-	238.4	1.374	14	LAD10+LAL10+LAL13L+LA100+LAP13L+LAP10+LAD10+NL41
LAV11L	1908	2208	991	1291	1105	4 525,-	252.3	1.421	14	LAD10+LAL10+LAL13L+LA100+LAP16L+LAP10+LAD10+NL41
LAV12L	1908	2908	991	1991	1105	5 080,-	278.8	1.546	15	LAD10+LAL10+LAL13L+LA100+LAP23L+LAP10+LAD10+NL41
LAV13L	2208	1908	1291	991	1105	4 525,-	252.3	1.421	14	LAD10+LAL10+LAL16L+LA100+LAP13L+LAP10+LAD10+NL41
LAV14L	2208	2208	1291	1291	1105	4 755,-	266.2	1.468	14	LAD10+LAL10+LAL16L+LA100+LAP16L+LAP10+LAD10+NL41
LAV15L	2208	2908	1291	1991	1105	5 310,-	292.7	1.593	15	LAD10+LAL10+LAL16L+LA100+LAP23L+LAP10+LAD10+NL41

ADDITIONAL CHARGE

FEATURE	PRODUCT												COMMENTS
	LAV01L	LAV02L	LAV03L	LAV10L	LAV11L	LAV12L	LAV13L	LAV14L	LAV15L	kg	m <sup>3</sup>	pcs	
MONITOR SHELF x 1	160,-	160,-	160,-	160,-	160,-	160,-	160,-	160,-	160,-	0.1	0.0001	1	
MONITOR SHELF x 2				320,-	320,-	320,-	320,-	320,-	320,-	0.9	0.0070	1	

DESCRIPTION

- NET WEIGHT

VOLUME

NUMBER OF PACKAGES



RECEPTION DESKS SYSTEMS

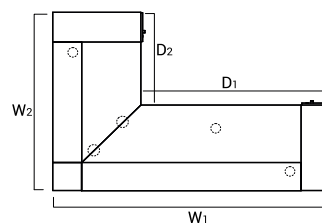
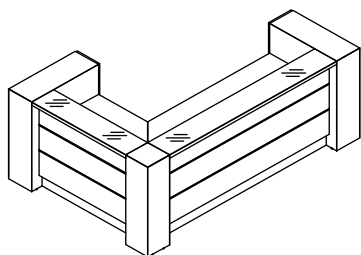

INDEX SYMBOL	DIMENSIONS [mm]					PRICE EUR				COMPONENTS
	W <sub>1</sub>	W <sub>2</sub>	D <sub>1</sub>	D <sub>2</sub>	H		kg	m <sup>3</sup>	pcs	
LAV16L	2908	1908	1991	991	1105	5 080,-	278.8	1.546	15	LAD10+LAL10+LAL23L+LA100 +LAP13L+LAP10+LAD10+NL41
LAV17L	2908	2208	1991	1291	1105	5 310,-	292.7	1.593	15	LAD10+LAL10+LAL23L+LA100 +LAP16L+LAP10+LAD10+NL41
LAV18L	2908	2908	1991	1991	1105	5 865,-	319.2	1.717	16	LAD10+LAL10+LAL23L+LA100 +LAP23L+LAP10+LAD10+NL41

ADDITIONAL CHARGE

FEATURE	PRODUCT												COMMENTS
	LAV16L	LAV17L	LAV18L							kg	m <sup>3</sup>	pcs	
MONITOR SHELF x 1	160,-	160,-	160,-							0.1	0.0001	1	
MONITOR SHELF x 2	320,-	320,-	320,-							0.9	0.0070	1	

DESCRIPTION

- NET WEIGHT

VOLUME

NUMBER OF PACKAGES

RECEPTION DESKS SYSTEMS

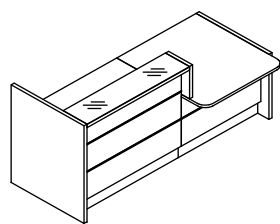

A

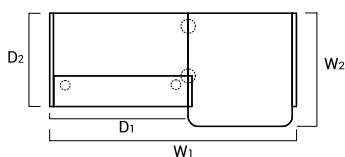

B

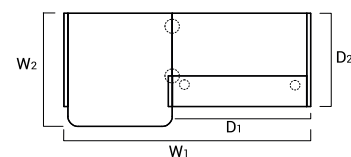

INDEX SYMBOL	DIMENSIONS [mm]					PRICE EUR				COMPONENTS
	W <sub>1</sub>	W <sub>2</sub>	D <sub>1</sub>	D <sub>2</sub>	H		kg	m <sup>3</sup>	pcs	
A LAV19L	2366	1114	1328	917	1105	2 985,-	138.9	0.509	12	LAN6L+LAU11L+LAN4L+LA13L+LAN1P+NL41
B LAV20L	2366	1114	1328	917	1105	2 985,-	138.9	0.509	12	LAN1P+LA13L+LAN3P+LAU11L+LAN5P+NL41
A LAV21L	2666	1114	1628	917	1105	3 215,-	152.3	0.556	12	LAN6L+LAU11L+LAN4L+LA16L+LAN1P+NL41
B LAV22L	2666	1104	1628	917	1105	3 215,-	152.3	0.556	12	LAN1P+LA16L+LAN3P+LAU11L+LAN5P+NL41
A LAV23L	3366	1114	2318	917	1105	3 770,-	178.8	0.680	13	LAN6L+LAU11L+LAN4L+LA23L+LAN1P+NL41
B LAV24L	3366	1114	2318	917	1105	3 770,-	178.8	0.680	13	LAN1P+LA23L+LAN3P+LAU11L+LAN5P+NL41
A LAV191L	2166	1114	1328	917	1105	2 875,-	134.9	0.486	12	LAN6L+LAU11L+LAN4L+LA13L+LAN1P+NL41
B LAV201L	2366	1114	1328	917	1105	2 875,-	134.9	0.486	12	LAN1P+LA13L+LAN3P+LAU11L+LAN5P+NL41
A LAV211L	2466	1114	1628	917	1105	3 105,-	148.3	0.533	12	LAN6L+LAU11L+LAN4L+LA16L+LAN1P+NL41
B LAV221L	2466	1104	1628	917	1105	3 105,-	148.3	0.533	12	LAN1P+LA16L+LAN3P+LAU11L+LAN5P+NL41
A LAV231L	3166	1114	2318	917	1105	3 660,-	174.8	0.657	13	LAN6L+LAU11L+LAN4L+LA23L+LAN1P+NL41
B LAV241L	3166	1114	2318	917	1105	3 660,-	174.8	0.657	13	LAN1P+LA23L+LAN3P+LAU11L+LAN5P+NL41

ADDITIONAL CHARGE

FEATURE	PRODUCT															COMMENTS
	LAV19L	LAV20L	LAV21L	LAV22L	LAV23L	LAV24L	LAV191L	LAV201L	LAV211L	LAV221L	LAV231L	LAV241L	kg	m <sup>3</sup>	pcs	
MONITOR SHELF x 1	160,-	160,-	160,-	160,-	160,-	160,-	160,-	160,-	160,-	160,-	160,-	160,-	0.1	0.0001	1	

DESCRIPTION

- NET WEIGHT

VOLUME

NUMBER OF PACKAGES

RECEPTION DESKS SYSTEMS

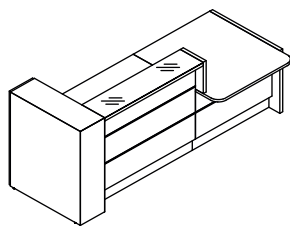

A

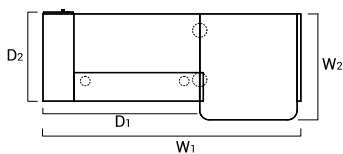

B

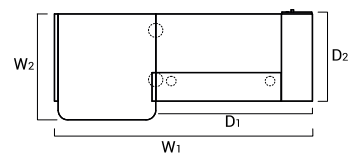

INDEX SYMBOL	DIMENSIONS [mm]					PRICE EUR				COMPONENTS
	W <sub>1</sub>	W <sub>2</sub>	D <sub>1</sub>	D <sub>2</sub>	H		kg	m <sup>3</sup>	pcs	
A LAV41L	2646	1134	1608	937	1105	3 365,-	167.4	0.833	13	LAN6L+LAU11L+LAN4L+LA13L +LAP10+LAD10+NL41
B LAV42L	2646	1134	1608	937	1105	3 365,-	167.4	0.833	13	LAD10+LAL10+LA13L+LAN3P +LAU11L+LAN5P+NL41
A LAV43L	2946	1134	1908	937	1105	3 595,-	180.8	0.880	13	LAN6L+LAU11L+LAN4L+LA16L +LAP10+LAD10+NL41
B LAV44L	2946	1134	1908	937	1105	3 595,-	180.8	0.880	13	LAD10+LAL10+LA16L+LAN3P +LAU11L+LAN5P+NL41
A LAV45L	3646	1134	2608	937	1105	4 150,-	207.3	1.004	14	LAN6L+LAU11L+LAN4L+LA23L +LAP10+LAD10+NL41
B LAV46L	3646	1134	2608	937	1105	4 150,-	207.3	1.004	14	LAD10+LAL10+LA23L+LAN3P +LAU11L+LAN5P+NL41
A LAV411L	2446	1134	1608	937	1105	3 255,-	163.4	0.809	13	LAN6L+LAU11L+LAN4L+LA13L +LAP10+LAD10+NL41
B LAV421L	2446	1134	1608	937	1105	3 255,-	163.4	0.809	13	LAD10+LAL10+LA13L+LAN3P +LAU11L+LAN5P+NL41
A LAV431L	2746	1134	1908	937	1105	3 485,-	176.8	0.856	13	LAN6L+LAU11L+LAN4L+LA16L +LAP10+LAD10+NL41
B LAV441L	2746	1134	1908	937	1105	3 485,-	176.8	0.856	13	LAD10+LAL10+LA16L+LAN3P +LAU11L+LAN5P+NL41
A LAV451L	3446	1134	2608	937	1105	4 040,-	203.3	0.981	14	LAN6L+LAU11L+LAN4L+LA23L +LAP10+LAD10+NL41
B LAV461L	3446	1134	2608	937	1105	4 040,-	203.3	0.981	14	LAD10+LAL10+LA23L+LAN3P +LAU11L+LAN5P+NL41

ADDITIONAL CHARGE

FEATURE	PRODUCT															COMMENTS
	LAV41L	LAV42L	LAV43L	LAV44L	LAV45L	LAV46L	LAV411L	LAV421L	LAV431L	LAV441L	LAV451L	LAV461L	kg	m <sup>3</sup>	pcs	
MONITOR SHELF x 1	160,-	160,-	160,-	160,-	160,-	160,-	160,-	160,-	160,-	160,-	160,-	160,-	0.1	0.0001	1	

DESCRIPTION

- NET WEIGHT

VOLUME

NUMBER OF PACKAGES

RECEPTION DESKS SYSTEMS

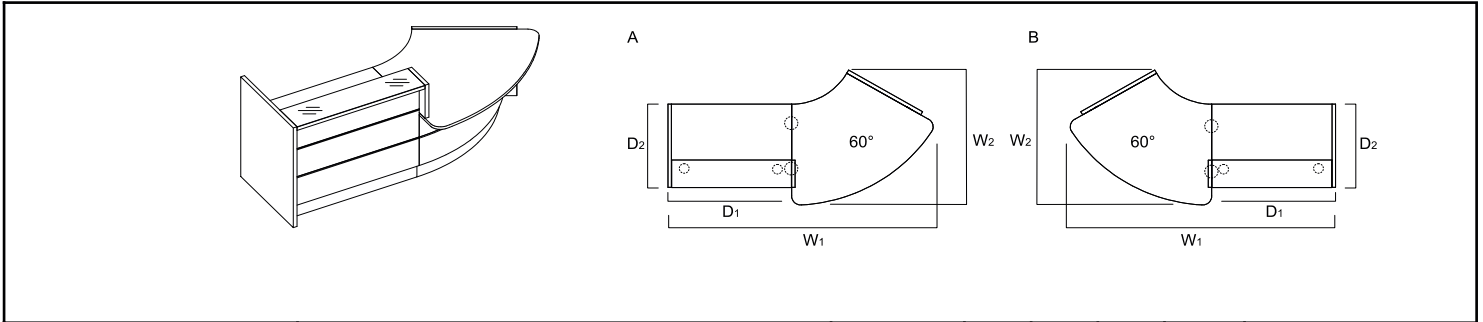

INDEX SYMBOL	DIMENSIONS [mm]					PRICE EUR	kg	m3	pcs	COMPONENTS
	W <sub>1</sub>	W <sub>2</sub>	D <sub>1</sub>	D <sub>2</sub>	H					
A <b>LAV88L</b>	2845	1486	1328	917	1105	3 300,-	160.9	0.832	12	LAN6L+LAV66L+LAN4L+LA13L+LAN1P+NL41
B <b>LAV89L</b>	2845	1486	1328	917	1105	3 300,-	160.9	0.832	12	LAN2L+LA13L+LAN3P+LAV66L+LAN5P+NL41
A <b>LAV91L</b>	3145	1486	1628	917	1105	3 530,-	174.3	0.879	12	LAN6L+LAV66L+LAN4L+LA16L+LAN1P+NL41
B <b>LAV92L</b>	3145	1486	1628	917	1105	3 530,-	174.3	0.879	12	LAN2L+LA16L+LAN3P+LAV66L+LAN5P+NL41

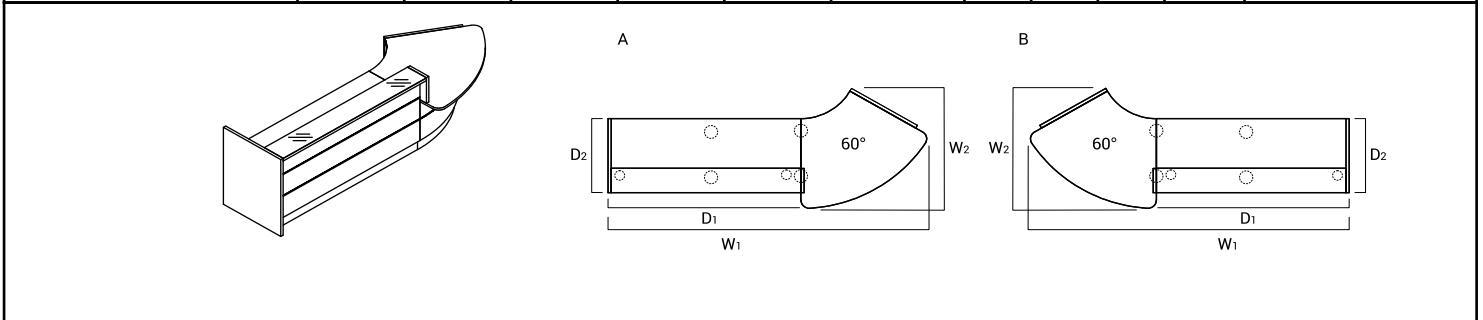

INDEX SYMBOL	DIMENSIONS [mm]					PRICE EUR	kg	m3	pcs	COMPONENTS
	W <sub>1</sub>	W <sub>2</sub>	D <sub>1</sub>	D <sub>2</sub>	H					
A <b>LAV93L</b>	3845	1486	2318	917	1105	4 085,-	200.8	1.003	13	LAN6L+LAV66L+LAN4L+LA23L+LAN1P+NL41
B <b>LAV94L</b>	3845	1486	2318	917	1105	4 085,-	200.8	1.003	13	LAN2L+LA23L+LAN3P+LAV66L+LAN5P+NL41

ADDITIONAL CHARGE

FEATURE	PRODUCT						kg	m3	pcs	COMMENTS
	LAV88L	LAV89L	LAV91L	LAV92L	LAV93L	LAV94L				
MONITOR SHELF x 1	160,-	160,-	160,-	160,-	160,-	160,-	0.1	0.0001	1	

DESCRIPTION

- NET WEIGHT

VOLUME

NUMBER OF PACKAGES

RECEPTION DESKS SYSTEMS

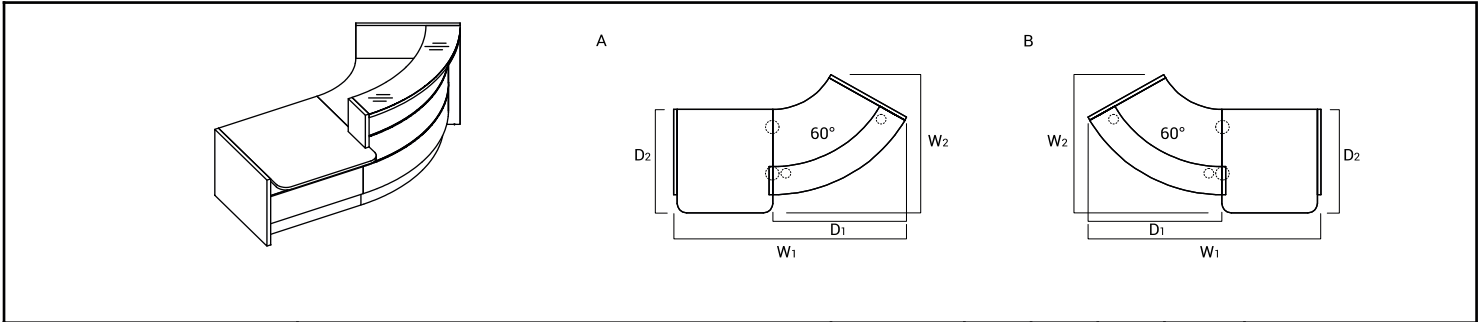

INDEX SYMBOL	DIMENSIONS [mm]					PRICE EUR	kg	m3	pcs	COMPONENTS
	W <sub>1</sub>	W <sub>2</sub>	D <sub>1</sub>	D <sub>2</sub>	H					
A <b>LAV84L</b>	2443	1489	1404	1114	1105	3 720,-	149.8	0.957	12	LAN2L+LAV64L+LAN3P+LAU11L+LAN5P+NL41
B <b>LAV85L</b>	2443	1489	1404	1114	1105	3 720,-	149.8	0.957	12	LAN6L+LAU11L+LAN4L+LAV64L+LAN1P+NL41
A <b>LAV841L</b>	2243	1489	1404	1114	1105	3 610,-	145.8	0.934	12	LAN2L+LAV64L+LAN3P+LAU111L+LAN5P+NL41
B <b>LAV851L</b>	2243	1489	1404	1114	1105	3 610,-	145.8	0.934	12	LAN6L+LAU111L+LAN4L+LAV64L+LAN1P+NL41

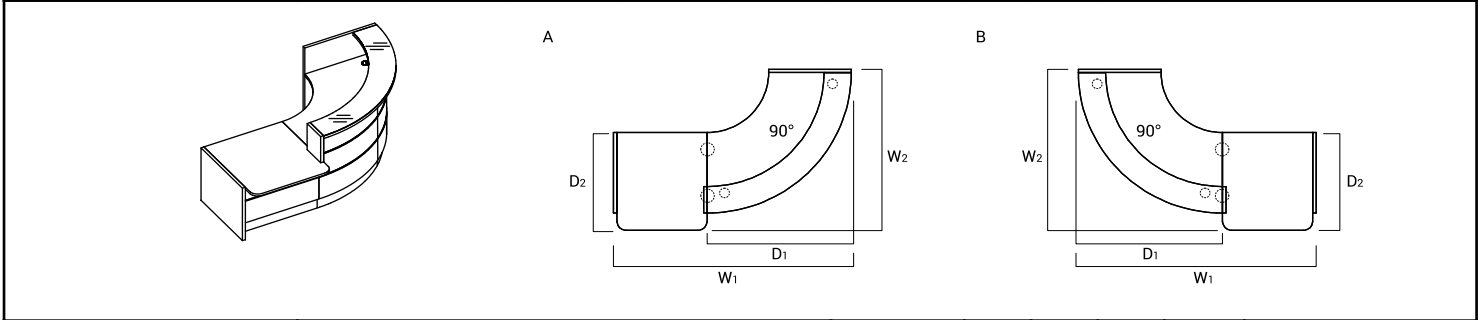

INDEX SYMBOL	DIMENSIONS [mm]					PRICE EUR	kg	m3	pcs	COMPONENTS
	W <sub>1</sub>	W <sub>2</sub>	D <sub>1</sub>	D <sub>2</sub>	H					
A <b>LAV86L</b>	2638	1835	1600	937	1105	4 350,-	190.8	1.328	13	LAN2L+LAV90L+LAN3P+LAU11L+LAN5P+NL41
B <b>LAV87L</b>	2638	1835	1600	937	1105	4 350,-	190.8	1.328	13	LAN6L+LAU11L+LAN4L+LAV90L+LAN1P+NL41
A <b>LAV861L</b>	2438	1835	1600	937	1105	4 240,-	186.8	1.305	13	LAN2L+LAV90L+LAN3P+LAU111L+LAN5P+NL41
B <b>LAV871L</b>	2438	1835	1600	937	1105	4 240,-	186.8	1.305	13	LAN6L+LAU111L+LAN4L+LAV90L+LAN1P+NL41

ADDITIONAL CHARGE

FEATURE	PRODUCT								kg	m3	pcs	COMMENTS
	LAV84L	LAV85L	LAV841L	LAV851L	LAV86L	LAV87L	LAV861L	LAV871L				
MONITOR SHELF x 1	160,-	160,-	160,-	160,-	160,-	160,-	160,-	160,-	0.1	0.0001	1	

DESCRIPTION

- NET WEIGHT

VOLUME

NUMBER OF PACKAGES

RECEPTION DESKS SYSTEMS

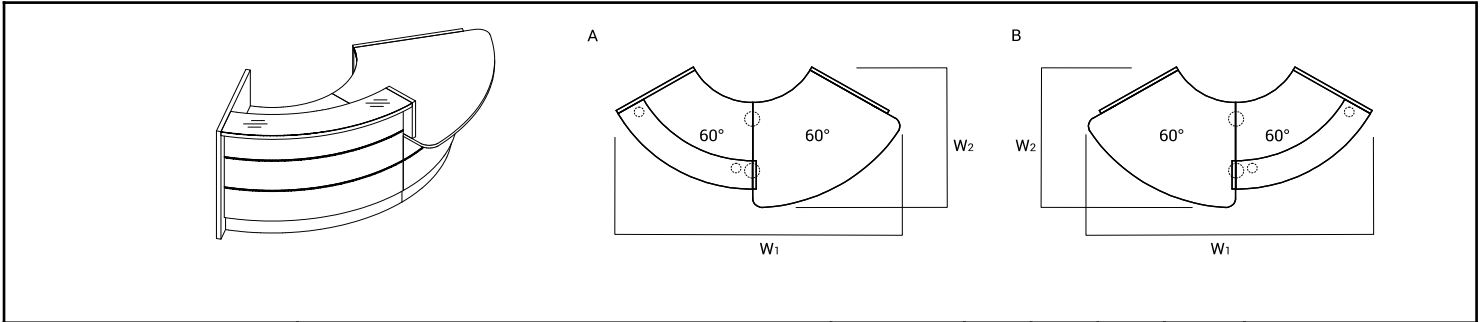

INDEX SYMBOL	DIMENSIONS [mm]					PRICE EUR				COMPONENTS
	W <sub>1</sub>	W <sub>2</sub>	D <sub>1</sub>	D <sub>2</sub>	H		kg	m <sup>3</sup>	pcs	
A <b>LAV30L</b>	2922	1486	-	-	1105	4 035,-	171.8	1.280	12	LAN6L+LAV66L+LAN4L+LAV64L+LAN1P+NL41
B <b>LAV31L</b>	2922	1486	-	-	1105	4 035,-	171.8	1.280	12	LAN2L+LAV64L+LAN3P+LAV66L+LAN5P+NL41

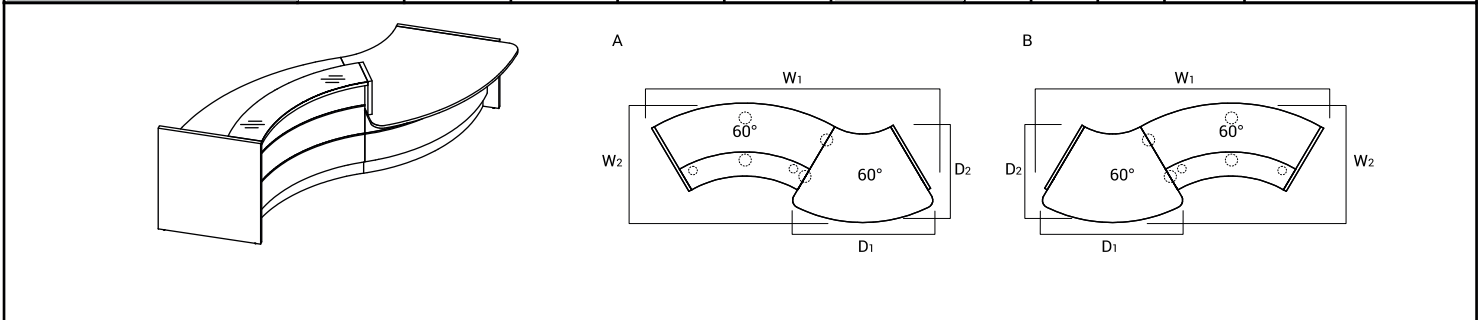

INDEX SYMBOL	DIMENSIONS [mm]					PRICE EUR				COMPONENTS
	W <sub>1</sub>	W <sub>2</sub>	D <sub>1</sub>	D <sub>2</sub>	H		kg	m <sup>3</sup>	pcs	
A <b>LAV32L</b>	3452	1502	1720	1225	1105	4 085,-	182.8	1.366	13	LAN6L+LAV66L+LAN4L+LAV62L+LAN1P+NL41
B <b>LAV33L</b>	3452	1502	-	-	1105	4 085,-	182.8	1.366	13	LAN2L+LAV62L+LAN3P+LAV66L+LAN5P+NL41

ADDITIONAL CHARGE

FEATURE	PRODUCT											COMMENTS
	LAV30L	LAV31L	LAV32L	LAV33L					kg	m <sup>3</sup>	pcs	
MONITOR SHELF x 1	160,-	160,-	160,-	160,-					0.1	0.0001	1	

DESCRIPTION

- NET WEIGHT

VOLUME

NUMBER OF PACKAGES

RECEPTION DESKS SYSTEMS

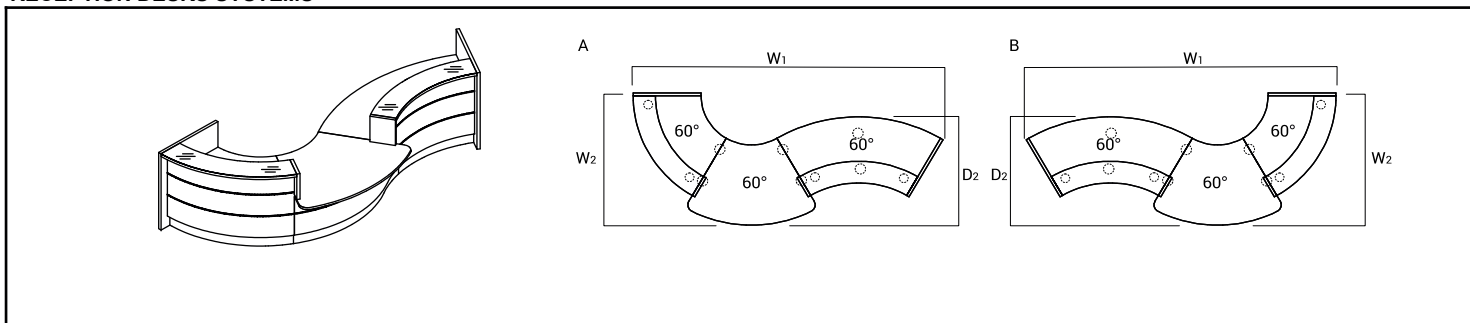

INDEX SYMBOL	DIMENSIONS [mm]					PRICE EUR				COMPONENTS
	W <sub>1</sub>	W <sub>2</sub>	D <sub>1</sub>	D <sub>2</sub>	H		kg	m <sup>3</sup>	pcs	
A <b>LAV34L</b>	4195	1835	-	1503	1105	6 380,-	262.1	2.129	20	LAN2L+LAV62L+LAN3P+LAV66L +LAN4L+LAV64L+LAN1P+2xNL41
B <b>LAV35L</b>	4195	1835	-	-	1105	6 380,-	262.1	2.129	20	LAN2L+LAV64L+LAN3P+LAV66L +LAN4L+LAV62L+LAN1P+2xNL41

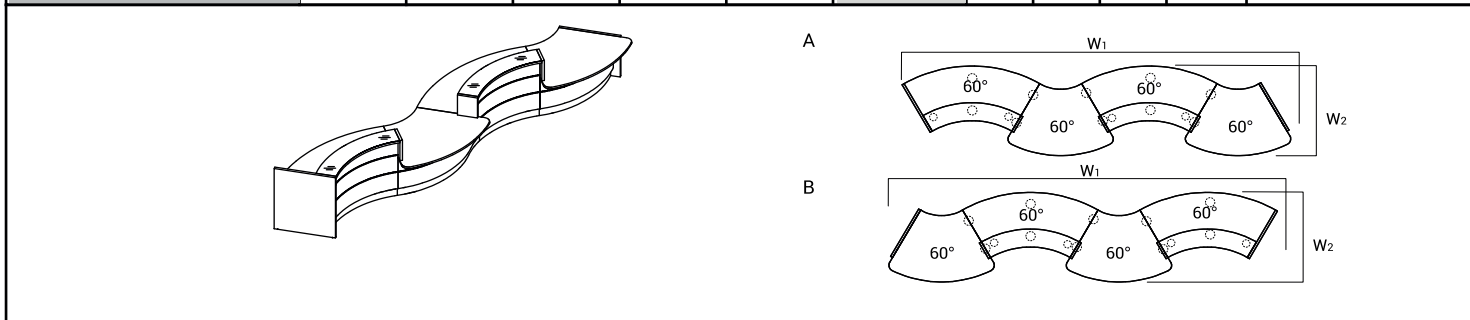

INDEX SYMBOL	DIMENSIONS [mm]					PRICE EUR				COMPONENTS
	W <sub>1</sub>	W <sub>2</sub>	D <sub>1</sub>	D <sub>2</sub>	H		kg	m <sup>3</sup>	pcs	
A <b>LAV36L</b>	6352	1503	-	-	1105	7 910,-	325.4	2.715	26	LAN6L+2xLAV66L+2xLAN4L +2xLAV62L+LAN3P+LAN1P +3xNL41
B <b>LAV37L</b>	6352	1503	-	-	1105	7 910,-	325.4	2.715	26	LAN2L+2xLAV62L+2xLAN3P +2xLAV66L+LAN4L+LAN5P +3xNL41

ADDITIONAL CHARGE

FEATURE	PRODUCT											COMMENTS
	LAV34L	LAV35L	LAV36L	LAV37L					kg	m <sup>3</sup>	pcs	
MONITOR SHELF x 1	160,-	160,-	160,-	160,-					0.1	0.0001	1	
MONITOR SHELF x 2	320,-	320,-	320,-	320,-					0.9	0.0070	1	

DESCRIPTION

- NET WEIGHT

VOLUME

NUMBER OF PACKAGES

RECEPTION DESKS SYSTEMS

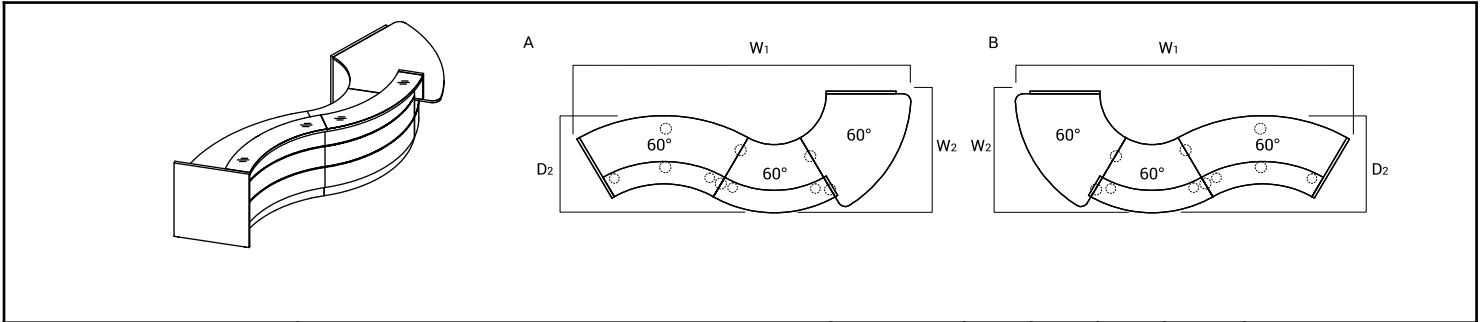

INDEX SYMBOL	DIMENSIONS [mm]					PRICE EUR				COMPONENTS
	W <sub>1</sub>	W <sub>2</sub>	D <sub>1</sub>	D <sub>2</sub>	H		kg	m <sup>3</sup>	pcs	
A <b>LAV38L</b>	4386	1639	-	1307	1105	6 270,-	252.3	2.106	19	LAN6L+LAV66L+LAN4L+LAV64L+LAV62L+LAN1P+2xNL41
B <b>LAV39L</b>	4386	1639	-	1307	1105	6 270,-	252.3	2.106	19	LAN2L+LAV62L+LAV64L+LAN3P+LAV66L+LAN5P+2xNL41

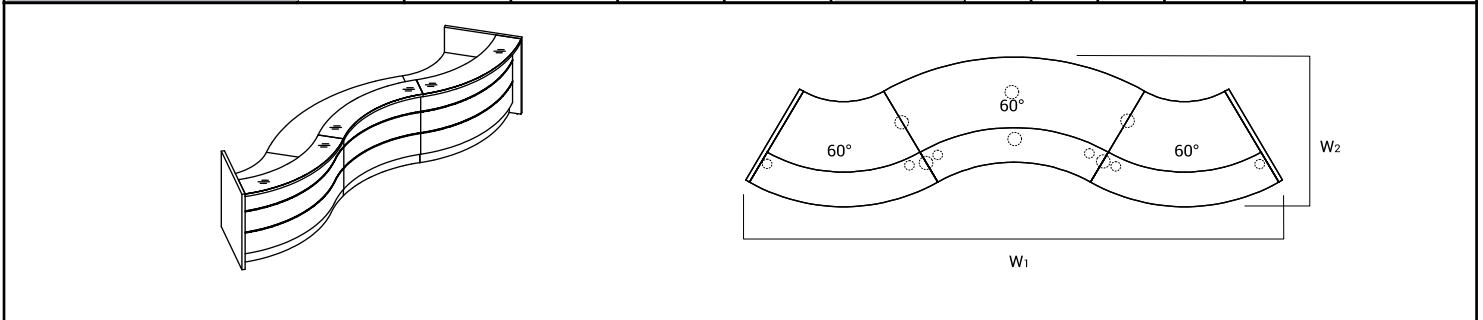

INDEX SYMBOL	DIMENSIONS [mm]					PRICE EUR				COMPONENTS
	W <sub>1</sub>	W <sub>2</sub>	D <sub>1</sub>	D <sub>2</sub>	H		kg	m <sup>3</sup>	pcs	
<b>LAV50L</b>	4566	1307	-	-	1105	6 975,-	260.5	2.329	17	LAN2L+2xLAV64L+LAV62L+LAN1P+2xNL41

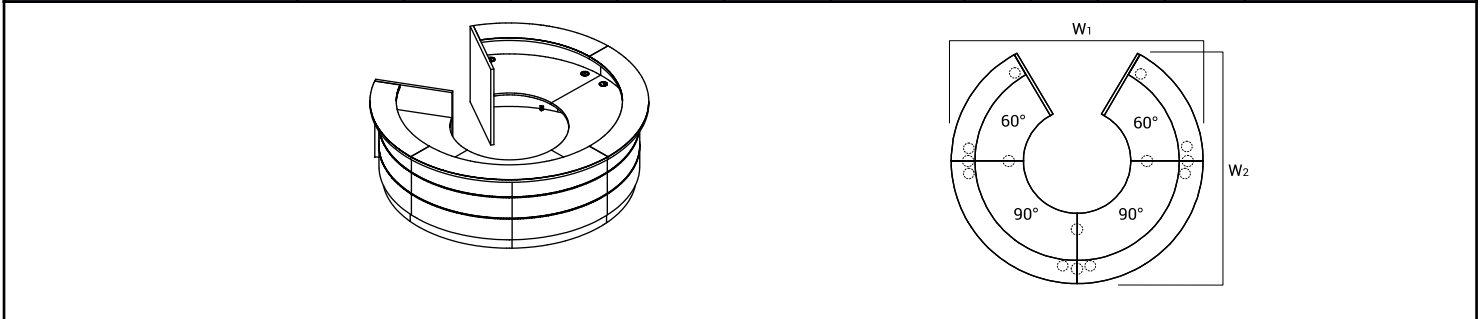

INDEX SYMBOL	DIMENSIONS [mm]					PRICE EUR				COMPONENTS
	W <sub>1</sub>	W <sub>2</sub>	D <sub>1</sub>	D <sub>2</sub>	H		kg	m <sup>3</sup>	pcs	
<b>LAV51L</b>	3202	3006	-	-	1105	10 370,-	410.0	3.741	27	LAN2L+2xLAV64L+2xLAV90L+LAN1P+3xNL41

ADDITIONAL CHARGE

FEATURE	PRODUCT											COMMENTS
	LAV38L	LAV39L	LAV50L	LAV51L					kg	m <sup>3</sup>	pcs	
MONITOR SHELF x 1	160,-	160,-	160,-	160,-					0.1	0.0001	1	
MONITOR SHELF x 2	320,-	320,-	320,-	320,-					0.9	0.0070	1	
MONITOR SHELF x 3			480,-	480,-					0.9	0.0070	1	
MONITOR SHELF x 4				640,-					0.0	0.0000	0	

DESCRIPTION

- NET WEIGHT

VOLUME

NUMBER OF PACKAGES



RECEPTION DESKS SYSTEMS

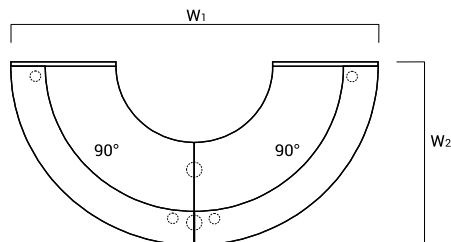
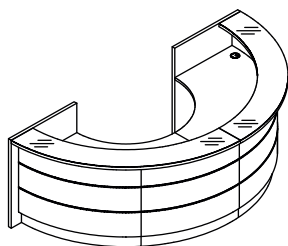

INDEX SYMBOL	DIMENSIONS [mm]					PRICE EUR				COMPONENTS
	W <sub>1</sub>	W <sub>2</sub>	D <sub>1</sub>	D <sub>2</sub>	H		kg	m <sup>3</sup>	pcs	
LAV52L	3202	1639	-	-	1105	6 000,-	271.0	2.261	15	LAN2L+2xLAV90L+LAN1P+NL41

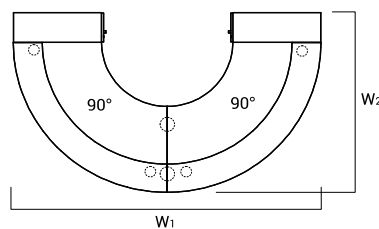
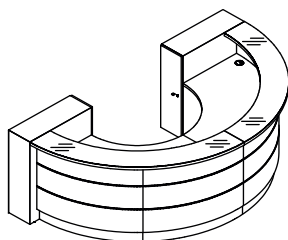

INDEX SYMBOL	DIMENSIONS [mm]					PRICE EUR				COMPONENTS
	W <sub>1</sub>	W <sub>2</sub>	D <sub>1</sub>	D <sub>2</sub>	H		kg	m <sup>3</sup>	pcs	
LAV61L	3202	1919	-	-	1105	6 760,-	322.0	2.898	15	LAD10+LAL10+2xLAV90L+LAP10+LAD10+NL41

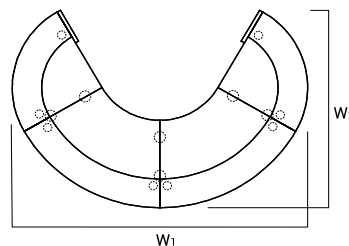
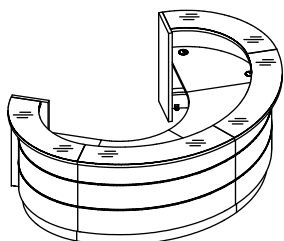

INDEX SYMBOL	DIMENSIONS [mm]					PRICE EUR				COMPONENTS
	W <sub>1</sub>	W <sub>2</sub>	D <sub>1</sub>	D <sub>2</sub>	H		kg	m <sup>3</sup>	pcs	
LAV04L	3202	3006	-	-	1105	8 710,-	250.0	2.312	23	LAN8L+2xLAV70L+2xLAV64L+LAN7P+3xNL41

ADDITIONAL CHARGE

FEATURE	PRODUCT											COMMENTS
	LAV52L	LAV61L	LAV04L						kg	m <sup>3</sup>	pcs	
MONITOR SHELF x 1	160,-	160,-	160,-						0.1	0.0001	1	
MONITOR SHELF x 2	320,-	320,-	320,-						0.9	0.0070	1	

DESCRIPTION

- NET WEIGHT

VOLUME

NUMBER OF PACKAGES

RECEPTION DESKS SYSTEMS

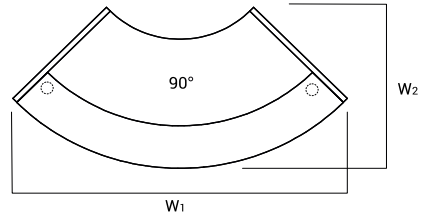
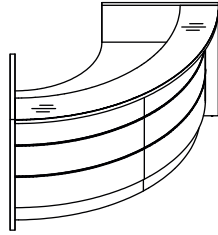

INDEX SYMBOL	DIMENSIONS [mm]					PRICE EUR				COMPONENTS
	W <sub>1</sub>	W <sub>2</sub>	D <sub>1</sub>	D <sub>2</sub>	H		kg	m <sup>3</sup>	pcs	
LAV53L	2317	1145	-	-	1105	3 185,-	160.5	1.150	8	LAN2L+LAV90L+LAN1P

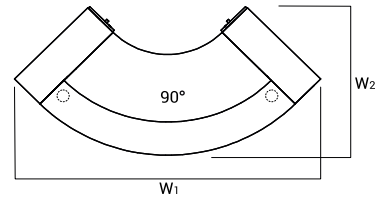
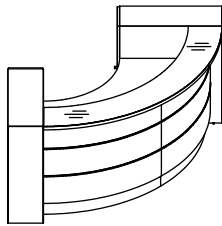

INDEX SYMBOL	DIMENSIONS [mm]					PRICE EUR				COMPONENTS
	W <sub>1</sub>	W <sub>2</sub>	D <sub>1</sub>	D <sub>2</sub>	H		kg	m <sup>3</sup>	pcs	
LAV73L	2713	1353	-	-	1105	3 945,-	217.5	1.798	10	LAD10+LAL10+LAV90L+LAP10 +LAD10

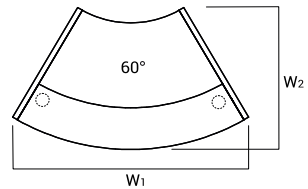
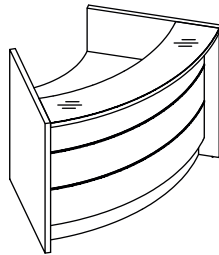

INDEX SYMBOL	DIMENSIONS [mm]					PRICE EUR				COMPONENTS
	W <sub>1</sub>	W <sub>2</sub>	D <sub>1</sub>	D <sub>2</sub>	H		kg	m <sup>3</sup>	pcs	
LAV54L	1666	1029	-	-	1105	2 555,-	119.5	0.779	7	LAN2L+LAV64L+LAN1P

ADDITIONAL CHARGE

FEATURE	PRODUCT													COMMENTS
	LAV53L	LAV73L	LAV54L								kg	m <sup>3</sup>	pcs	
MONITOR SHELF x 1	160,-	160,-	160,-								0.1	0.0001	1	

DESCRIPTION

- NET WEIGHT

VOLUME

NUMBER OF PACKAGES

RECEPTION DESKS SYSTEMS

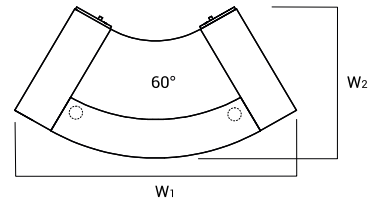
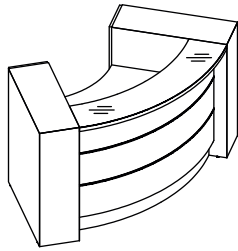

INDEX SYMBOL	DIMENSIONS [mm]					PRICE EUR				COMPONENTS
	W <sub>1</sub>	W <sub>2</sub>	D <sub>1</sub>	D <sub>2</sub>	H		kg	m <sup>3</sup>	pcs	
LAV74L	2151	1183	-	-	1105	3 315,-	176.5	1.427	9	LAD10+LAL10+LAV64L+LAP10+LAD10

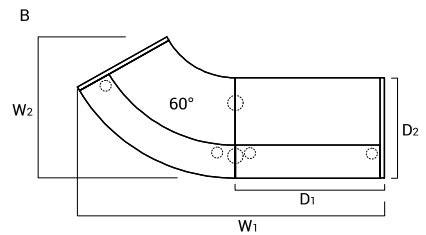
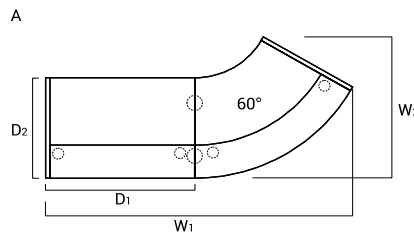
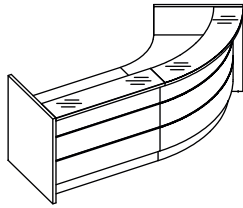

INDEX SYMBOL	DIMENSIONS [mm]					PRICE EUR				COMPONENTS
	W <sub>1</sub>	W <sub>2</sub>	D <sub>1</sub>	D <sub>2</sub>	H		kg	m <sup>3</sup>	pcs	
A LAV78L	2733	1292	1328	917	1105	4 005,-	178.1	1.071	13	LAN2L+LAV64L+LA13L+LAN1P+NL41
B LAV79L	2733	1292	1328	917	1105	4 005,-	178.1	1.071	13	LAN2L+LA13L+LAV64L+LAN1P+NL41
A LAV80L	3033	1292	1628	917	1105	4 235,-	191.5	1.118	13	LAN2L+LAV64L+LA16L+LAN1P+NL41
B LAV81L	3033	1292	1628	917	1105	4 235,-	191.5	1.118	13	LAN2L+LA16L+LAV64L+LAN1P+NL41
A LAV82L	3733	1292	2318	917	1105	4 790,-	218.0	1.242	14	LAN2L+LAV64L+LA23L+LAN1P+NL41
B LAV83L	3733	1292	2318	917	1105	4 790,-	218.0	1.242	14	LAN2L+LA23L+LAV64L+LAN1P+NL41

ADDITIONAL CHARGE

FEATURE	PRODUCT											COMMENTS
	LAV74L	LAV78L	LAV79L	LAV80L	LAV81L	LAV82L	LAV83L		kg	m <sup>3</sup>	pcs	
MONITOR SHELF x 1	160,-	160,-	160,-	160,-	160,-	160,-	160,-		0.1	0.0001	1	
MONITOR SHELF x 2		320,-	320,-	320,-	320,-	320,-	320,-		0.9	0.0070	1	

DESCRIPTION

- NET WEIGHT

VOLUME

NUMBER OF PACKAGES

RECEPTION DESKS SYSTEMS

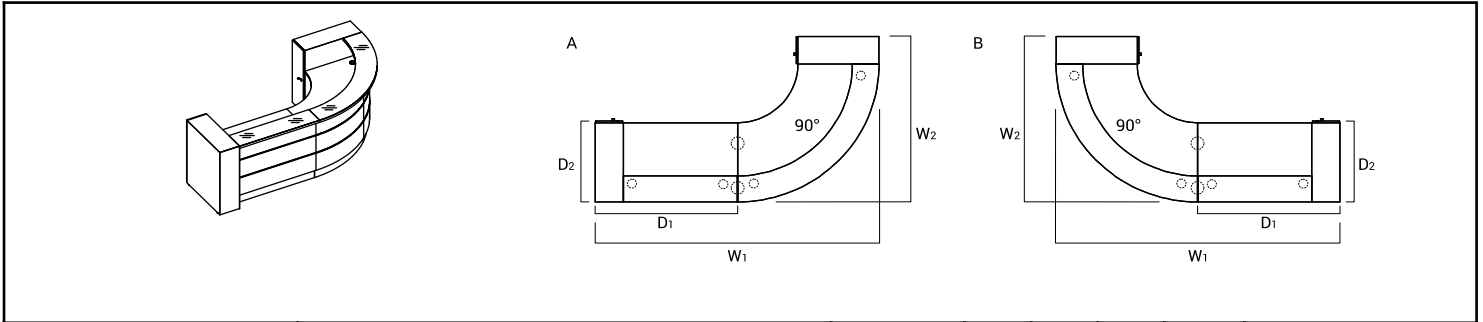

INDEX SYMBOL	DIMENSIONS [mm]					PRICE EUR				COMPONENTS
	W <sub>1</sub>	W <sub>2</sub>	D <sub>1</sub>	D <sub>2</sub>	H		kg	m <sup>3</sup>	pcs	
A <b>LAV55L</b>	3208	1918	1608	937	1105	5 395,-	276.1	2.089	16	LAD10+LAL10+LAV90L+LA13L +LAP10+LAD10+NL41
B <b>LAV56L</b>	3208	1918	1608	937	1105	5 395,-	276.1	2.089	16	LAD10+LAL10+LA13L+LAV90L +LAP10+LAD10+NL41
A <b>LAV57L</b>	3508	1918	1908	937	1105	5 625,-	289.5	2.137	16	LAD10+LAL10+LAV90L+LA16L +LAP10+LAD10+NL41
B <b>LAV58L</b>	3508	1918	1908	937	1105	5 625,-	289.5	2.137	16	LAD10+LAL10+LA16L+LAV90L +LAP10+LAD10+NL41

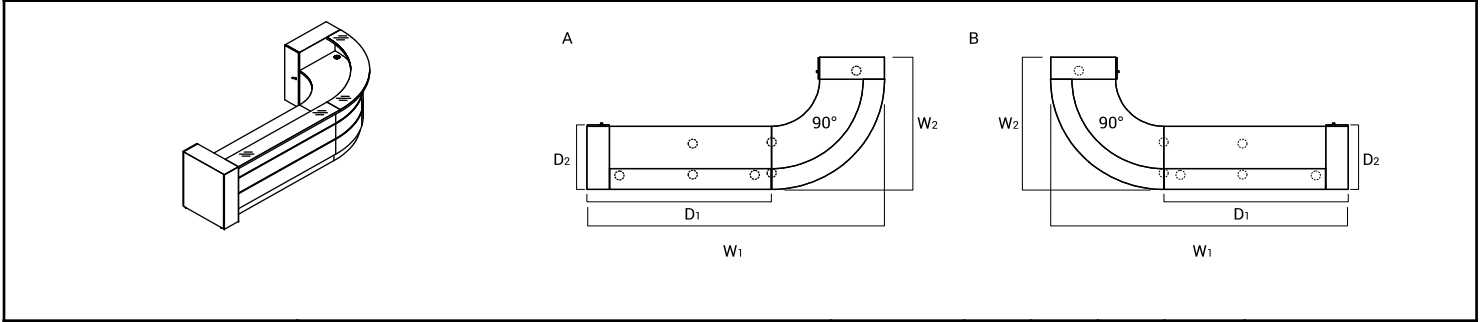

INDEX SYMBOL	DIMENSIONS [mm]					PRICE EUR				COMPONENTS
	W <sub>1</sub>	W <sub>2</sub>	D <sub>1</sub>	D <sub>2</sub>	H		kg	m <sup>3</sup>	pcs	
A <b>LAV59L</b>	4208	1918	2608	937	1105	6 180,-	316.0	2.261	17	LAD10+LAL10+LAV90L+LA23L +LAP10+LAD10+NL41
B <b>LAV60L</b>	4208	1918	2608	937	1105	6 180,-	316.0	2.261	17	LAD10+LAL10+LA23L+LAV90L +LAP10+LAD10+NL41

ADDITIONAL CHARGE

FEATURE	PRODUCT									COMMENTS
	LAV55L	LAV56L	LAV57L	LAV58L	LAV59L	LAV60L	kg	m <sup>3</sup>	pcs	
MONITOR SHELF x 1	160,-	160,-	160,-	160,-	160,-	160,-	0.1	0.0001	1	
MONITOR SHELF x 2	320,-	320,-	320,-	320,-	320,-	320,-	0.9	0.0070	1	

DESCRIPTION

- NET WEIGHT

VOLUME

NUMBER OF PACKAGES

RECEPTION DESKS SYSTEMS

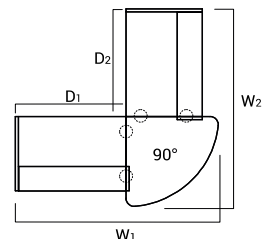
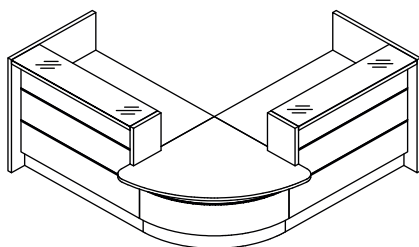

INDEX SYMBOL	DIMENSIONS [mm]					PRICE EUR				COMPONENTS
	W <sub>1</sub>	W <sub>2</sub>	D <sub>1</sub>	D <sub>2</sub>	H		kg	m <sup>3</sup>	pcs	
LAV101L	2437	2437	1328	1328	1105	4 805,-	204.3	0.950	17	LAN2L+LA13L+LAN3P+LAV68L +LAN4L+LA13L+LAN1P+2xNL41
LAV102L	2437	2737	1328	1628	1105	5 035,-	217.7	0.997	17	LAN2L+LA16L+LAN3P+LAV68L +LAN4L+LA13L+LAN1P+2xNL41
LAV103L	2437	3437	1328	2318	1105	5 590,-	244.2	1.121	18	LAN2L+LA23L+LAN3P+LAV68L +LAN4L+LA13L+LAN1P+2xNL41
LAV104L	2737	2437	1628	1328	1105	5 035,-	217.7	0.997	17	LAN2L+LA13L+LAN3P+LAV68L +LAN4L+LA16L+LAN1P+2xNL41
LAV105L	2737	2737	1628	1628	1105	5 265,-	231.1	1.044	17	LAN2L+LA16L+LAN3P+LAV68L +LAN4L+LA16L+LAN1P+2xNL41
LAV106L	2737	3437	1628	2318	1105	5 820,-	257.6	1.168	18	LAN2L+LA23L+LAN3P+LAV68L +LAN4L+LA16L+LAN1P+2xNL41

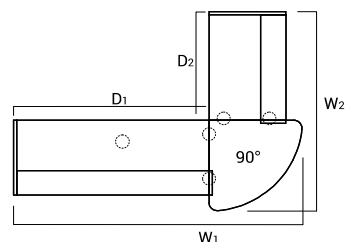
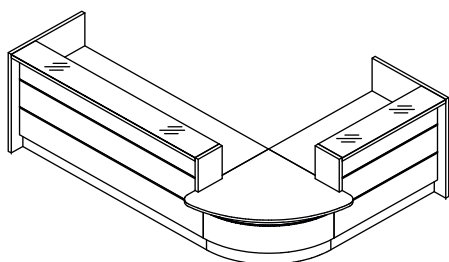

INDEX SYMBOL	DIMENSIONS [mm]					PRICE EUR				COMPONENTS
	W <sub>1</sub>	W <sub>2</sub>	D <sub>1</sub>	D <sub>2</sub>	H		kg	m <sup>3</sup>	pcs	
LAV107L	3437	2437	2318	1328	1105	5 590,-	244.2	1.121	18	LAN2L+LA13L+LAN3P+LAV68L +LAN4L+LA23L+LAN1P+2xNL41
LAV108L	3437	2737	2318	1628	1105	5 820,-	257.6	1.168	18	LAN2L+LA16L+LAN3P+LAV68L +LAN4L+LA23L+LAN1P+2xNL41
LAV109L	3437	3437	2318	2318	1105	6 375,-	284.1	1.293	19	LAN2L+LA23L+LAN3P+LAV68L +LAN4L+LA23L+LAN1P+2xNL41

ADDITIONAL CHARGE

FEATURE	PRODUCT												COMMENTS
	LAV101L	LAV102L	LAV103L	LAV104L	LAV105L	LAV106L	LAV107L	LAV108L	LAV109L	kg	m <sup>3</sup>	pcs	
MONITOR SHELF x 1	160,-	160,-	160,-	160,-	160,-	160,-	160,-	160,-	160,-	0.1	0.0001	1	
MONITOR SHELF x 2	320,-	320,-	320,-	320,-	320,-	320,-	320,-	320,-	320,-	0.9	0.0070	1	

DESCRIPTION

- NET WEIGHT

VOLUME

NUMBER OF PACKAGES

RECEPTION DESKS SYSTEMS

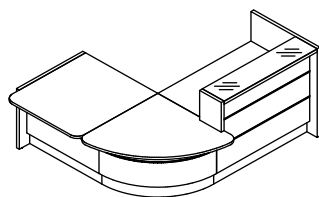

A

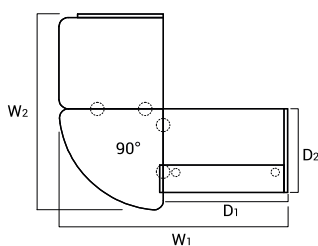

B

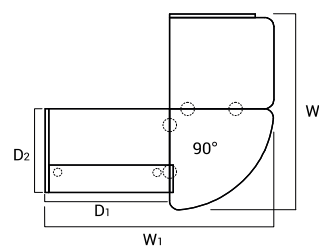

INDEX SYMBOL	DIMENSIONS [mm]					PRICE EUR				COMPONENTS
	W <sub>1</sub>	W <sub>2</sub>	D <sub>1</sub>	D <sub>2</sub>	H		kg	m <sup>3</sup>	pcs	
A LAV110L	2442	2147	1328	917	1105	4 380,-	176.4	0.832	16	LAN2L+LA13L+LAN3P+LAV68L+LAU111L+LAN5P+2xNL41
B LAV111L	2442	2147	1328	917	1105	4 380,-	176.4	0.832	16	LAN6L+LAN11L+LAV68L+LAN4L+LA13L+LAN1P+2xNL41
A LAV112L	2742	2147	1628	917	1105	4 610,-	189.8	0.879	16	LAN2L+LA16L+LAN3P+LAV68L+LAU111L+LAN5P+2xNL41
B LAV113L	2742	2147	1628	917	1105	4 610,-	189.8	0.879	16	LAN6L+LAN11L+LAV68L+LAN4L+LA16L+LAN1P+2xNL41
A LAV114L	3442	2147	2318	917	1105	5 165,-	216.3	1.004	17	LAN2L+LA23L+LAN3P+LAV68L+LAU111L+LAN5P+2xNL41
B LAV115L	3442	2147	2318	917	1105	5 165,-	216.3	1.004	17	LAN6L+LAN11L+LAV68L+LAN4L+LA23L+LAN1P+2xNL41
A LAV1101L	2442	1947	1328	917	1105	4 270,-	172.4	0.809	16	LAN2L+LA13L+LAN3P+LAV68L+LAU111L+LAN5P+2xNL41
B LAV1111L	2442	1947	1328	917	1105	4 270,-	172.4	0.809	16	LAN6L+LAN11L+LAV68L+LAN4L+LA13L+LAN1P+2xNL41
A LAV1121L	2742	1947	1628	917	1105	4 500,-	185.8	0.856	16	LAN2L+LA16L+LAN3P+LAV68L+LAU111L+LAN5P+2xNL41
B LAV1131L	2742	1947	1628	917	1105	4 500,-	185.8	0.856	16	LAN6L+LAN11L+LAV68L+LAN4L+LA16L+LAN1P+2xNL41
A LAV1141L	3442	1947	2318	917	1105	5 055,-	212.3	0.980	17	LAN2L+LA23L+LAN3P+LAV68L+LAU111L+LAN5P+2xNL41
B LAV1151L	3442	1947	2318	917	1105	5 055,-	212.3	0.980	17	LAN6L+LAN11L+LAV68L+LAN4L+LA23L+LAN1P+2xNL41

ADDITIONAL CHARGE

FEATURE	PRODUCT															COMMENTS
	LAV110L	LAV111L	LAV112L	LAV113L	LAV114L	LAV115L	LAV1101L	LAV1111L	LAV1121L	LAV1131L	LAV1141L	LAV1151L	kg	m <sup>3</sup>	pcs	
MONITOR SHELF x 1	160,-	160,-	160,-	160,-	160,-	160,-	160,-	160,-	160,-	160,-	160,-	160,-	0.1	0.0001	1	

DESCRIPTION

- NET WEIGHT

VOLUME

NUMBER OF PACKAGES

RECEPTION DESKS SYSTEMS

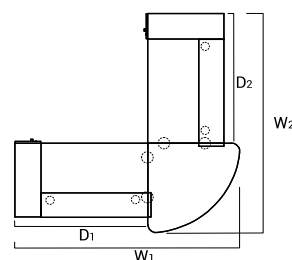
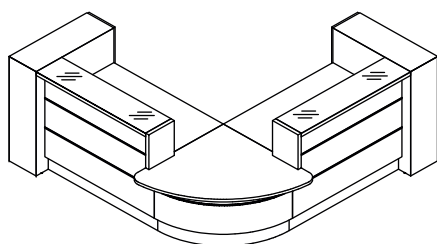

INDEX SYMBOL	DIMENSIONS [mm]					PRICE EUR				COMPONENTS
	W <sub>1</sub>	W <sub>2</sub>	D <sub>1</sub>	D <sub>2</sub>	H		kg	m <sup>3</sup>	pcs	
LAV116L	2717	2717	1608	1608	1105	5 565,-	261.3	1.597	19	LAD10+LAL10+LA13L+LAN3P +LAV68L+LAN4L+LA13L+LAP10 +LAD10+2xNL41
LAV117L	2717	3017	1608	1908	1105	5 795,-	274.7	1.644	19	LAD10+LAL10+LA16L+LAN3P +LAV68L+LAN4L+LA13L+LAP10 +LAD10+2xNL41
LAV118L	2717	3717	1608	2608	1105	6 350,-	301.2	1.769	20	LAD10+LAL10+LA23L+LAN3P +LAV68L+LAN4L+LA13L+LAP10 +LAD10+2xNL41
LAV119L	3017	2717	1908	1608	1105	5 795,-	274.7	1.644	19	LAD10+LAL10+LA13L+LAN3P +LAV68L+LAN4L+LA16L+LAP10 +LAD10+2xNL41
LAV120L	3017	3017	1908	1908	1105	6 025,-	288.1	1.691	19	LAD10+LAL10+LA16L+LAN3P +LAV68L+LAN4L+LA16L+LAP10 +LAD10+2xNL41
LAV121L	3017	3717	1908	2608	1105	6 580,-	314.6	1.816	20	LAD10+LAL10+LA23L+LAN3P +LAV68L+LAN4L+LA16L+LAP10 +LAD10+2xNL41

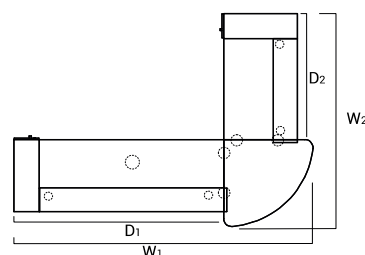
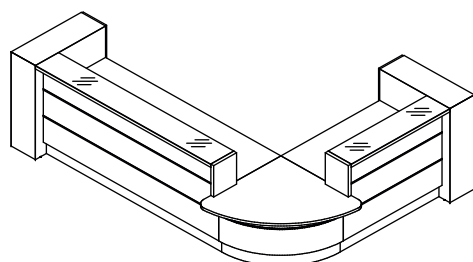

INDEX SYMBOL	DIMENSIONS [mm]					PRICE EUR				COMPONENTS
	W <sub>1</sub>	W <sub>2</sub>	D <sub>1</sub>	D <sub>2</sub>	H		kg	m <sup>3</sup>	pcs	
LAV122L	3717	2717	2608	1608	1105	6 350,-	301.2	1.769	20	LAD10+LAL10+LA13L+LAN3P +LAV68L+LAN4L+LA23L+LAP10 +LAD10+2xNL41
LAV123L	3717	3017	2608	1908	1105	6 580,-	314.6	1.816	20	LAD10+LAL10+LA16L+LAN3P +LAV68L+LAN4L+LA23L+LAP10 +LAD10+2xNL41
LAV124L	3717	3717	2608	2608	1105	7 135,-	341.1	1.940	21	LAD10+LAL10+LA23L+LAN3P +LAV68L+LAN4L+LA23L+LAP10 +LAD10+2xNL41

ADDITIONAL CHARGE

FEATURE	PRODUCT												COMMENTS
	LAV116L	LAV117L	LAV118L	LAV119L	LAV120L	LAV121L	LAV122L	LAV123L	LAV124L	kg	m <sup>3</sup>	pcs	
MONITOR SHELF x 1	160,-	160,-	160,-	160,-	160,-	160,-	160,-	160,-	160,-	0.1	0.0001	1	
MONITOR SHELF x 2	320,-	320,-	320,-	320,-	320,-	320,-	320,-	320,-	320,-	0.9	0.0070	1	

DESCRIPTION

- NET WEIGHT

VOLUME

NUMBER OF PACKAGES

RECEPTION DESKS SYSTEMS

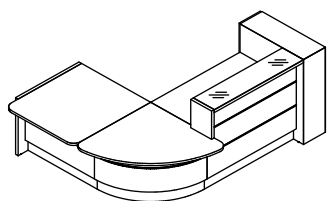

A

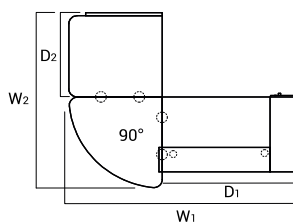

B

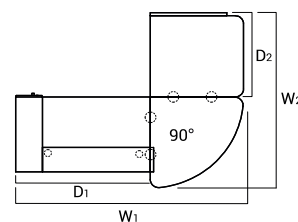

INDEX SYMBOL	DIMENSIONS [mm]					PRICE EUR	kg	m3	pcs	COMPONENTS
	W <sub>1</sub>	W <sub>2</sub>	D <sub>1</sub>	D <sub>2</sub>	H					
A LAV125L	2722	2147	1608	1038	1105	4 760,-	206.4	1.162	17	LAD10+LAL10+LA13L+LAN3P +LAV68L+LAU11L+LAN5P+2xNL41
B LAV126L	2722	2147	1608	1038	1105	4 760,-	201.9	1.151	16	LAN6L+LAU11L+LAV68L+LAN4L +LA13L+LAP10+LAD10+2xNL41
A LAV127L	3022	2147	1908	1038	1105	4 990,-	215.3	1.198	16	LAD10+LAL10+LA16L+LAN3P +LAV68L+LAU11L+LAN5P+2xNL41
B LAV128L	3022	2147	1908	1038	1105	4 990,-	215.3	1.198	16	LAN6L+LAU11L+LAV68L+LAN4L +LA16L+LAP10+LAD10+2xNL41
A LAV129L	3722	2147	2608	1038	1105	5 545,-	241.8	1.322	17	LAD10+LAL10+LA23L+LAN3P +LAV68L+LAU11L+LAN5P+2xNL41
B LAV130L	3722	2147	2608	1038	1105	5 545,-	241.8	1.322	17	LAN6L+LAU11L+LAV68L+LAN4L +LA23L+LAP10+LAD10+2xNL41
A LAV1251L	2722	1947	1608	838	1105	4 650,-	202.4	1.138	17	LAD10+LAL10+LA13L+LAN3P +LAV68L+LAU111L+LAN5P +2xNL41
B LAV1261L	2722	1947	1608	838	1105	4 650,-	197.9	1.128	16	LAN6L+LAU111L+LAV68L+LAN4L +LA13L+LAP10+LAD10+2xNL41
A LAV1271L	3022	1947	1908	838	1105	4 880,-	211.3	1.175	16	LAD10+LAL10+LA16L+LAN3P +LAV68L+LAU111L+LAN5P +2xNL41
B LAV1281L	3022	1947	1908	838	1105	4 880,-	211.3	1.175	16	LAN6L+LAU111L+LAV68L+LAN4L +LA16L+LAP10+LAD10+2xNL41
A LAV1291L	3722	1947	2608	838	1105	5 435,-	237.8	1.299	17	LAD10+LAL10+LA23L+LAN3P +LAV68L+LAU111L+LAN5P +2xNL41
B LAV1301L	3722	1947	2608	838	1105	5 435,-	237.8	1.299	17	LAN6L+LAU111L+LAV68L+LAN4L +LA23L+LAP10+LAD10+2xNL41

ADDITIONAL CHARGE

FEATURE	PRODUCT												kg	m3	pcs	COMMENTS
	LAV125L	LAV126L	LAV127L	LAV128L	LAV129L	LAV130L	LAV1251L	LAV1261L	LAV1271L	LAV1281L	LAV1291L	LAV1301L				
MONITOR SHELF x 1	160,-	160,-	160,-	160,-	160,-	160,-	160,-	160,-	160,-	160,-	160,-	160,-	0.1	0.0001	1	

DESCRIPTION

- NET WEIGHT

VOLUME

NUMBER OF PACKAGES



RECEPTION DESKS SYSTEMS

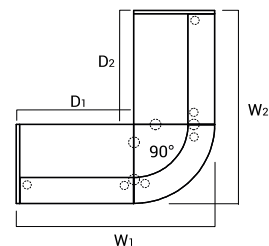
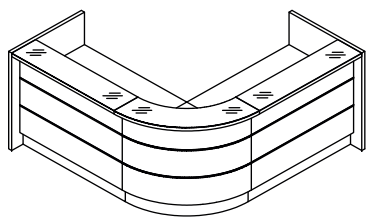

INDEX SYMBOL	DIMENSIONS [mm]					PRICE EUR				COMPONENTS
	W <sub>1</sub>	W <sub>2</sub>	D <sub>1</sub>	D <sub>2</sub>	H		kg	m <sup>3</sup>	pcs	
LAV131L	2245	2245	1328	1328	1105	5 350,-	206.7	1.036	16	LAN2L+LA13L+LAV70L+LA13L +LAN1P+2xNL41
LAV132L	2245	2545	1328	1628	1105	5 580,-	220.1	1.083	16	LAN2L+LA16L+LAV70L+LA13L +LAN1P+2xNL41
LAV133L	2245	3245	1328	2318	1105	6 135,-	246.6	1.208	17	LAN2L+LA23L+LAV70L+LA13L +LAN1P+2xNL41

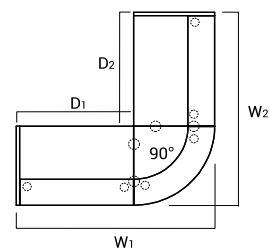
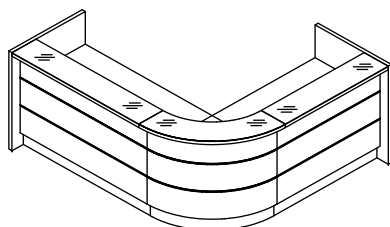

INDEX SYMBOL	DIMENSIONS [mm]					PRICE EUR				COMPONENTS
	W <sub>1</sub>	W <sub>2</sub>	D <sub>1</sub>	D <sub>2</sub>	H		kg	m <sup>3</sup>	pcs	
LAV134L	2545	2245	1628	1328	1105	5 580,-	220.1	1.083	16	LAN2L+LA13L+LAV70L+LA16L +LAN1P+2xNL41
LAV135L	2545	2545	1628	1628	1105	5 810,-	233.5	1.130	16	LAN2L+LA16L+LAV70L+LA16L +LAN1P+2xNL41
LAV136L	2545	3245	1628	2318	1105	6 365,-	260.0	1.255	17	LAN2L+LA23L+LAV70L+LA16L +LAN1P+2xNL41

ADDITIONAL CHARGE

FEATURE	PRODUCT									COMMENTS
	LAV131L	LAV132L	LAV133L	LAV134L	LAV135L	LAV136L	kg	m <sup>3</sup>	pcs	
MONITOR SHELF x 1	160,-	160,-	160,-	160,-	160,-	160,-	0.1	0.0001	1	
MONITOR SHELF x 2	320,-	320,-	320,-	320,-	320,-	320,-	0.9	0.0070	1	

DESCRIPTION

- NET WEIGHT

VOLUME

NUMBER OF PACKAGES

RECEPTION DESKS SYSTEMS

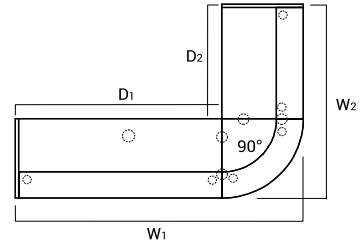
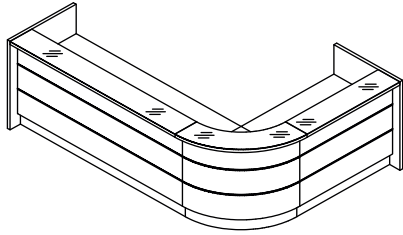

INDEX SYMBOL	DIMENSIONS [mm]					PRICE EUR				COMPONENTS
	W <sub>1</sub>	W <sub>2</sub>	D <sub>1</sub>	D <sub>2</sub>	H		kg	m <sup>3</sup>	pcs	
LAV137L	3245	2245	2318	1328	1105	6 135,-	246.6	1.208	17	LAN2L+LA13L+LAV70L+LA23L +LAN1P+2xNL41
LAV138L	3245	2545	2318	1628	1105	6 365,-	260.0	1.255	17	LAN2L+LA16L+LAV70L+LA23L +LAN1P+2xNL41
LAV139L	3245	3245	2318	2318	1105	6 920,-	286.5	1.379	18	LAN2L+LA23L+LAV70L+LA23L +LAN1P+2xNL41

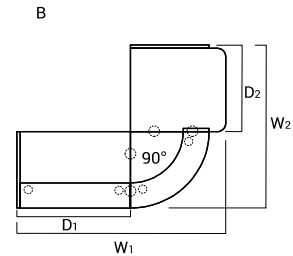
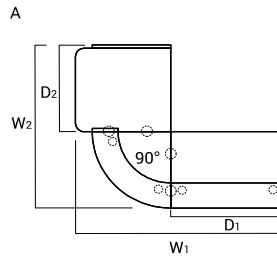
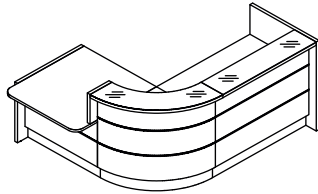

INDEX SYMBOL	DIMENSIONS [mm]					PRICE EUR				COMPONENTS
	W <sub>1</sub>	W <sub>2</sub>	D <sub>1</sub>	D <sub>2</sub>	H		kg	m <sup>3</sup>	pcs	
A LAV140L	2442	1955	1328	1038	1105	5 065,-	184.4	0.933	17	LAN2L+LA13L+LAV70L+LAN3P +LAU11L+LAN5P+2xNL41
B LAV141L	2442	1955	1328	1038	1105	5 065,-	184.4	0.933	17	LAN6L+LAU11L+LAN4L+LAV70L +LA13L+LAN1P+2xNL41
A LAV142L	2742	1955	1628	1038	1105	5 295,-	197.8	0.980	17	LAN2L+LA16L+LAV70L+LAN3P +LAU11L+LAN5P+2xNL41
B LAV143L	2742	1955	1628	1038	1105	5 295,-	197.8	0.980	17	LAN6L+LAU11L+LAN4L+LAV70L +LA16L+LAN1P+2xNL41
A LAV1401L	2442	1755	1328	838	1105	4 955,-	180.4	0.910	17	LAN2L+LA13L+LAV70L+LAN3P +LAU11L+LAN5P+2xNL41
B LAV1411L	2442	1755	1328	838	1105	4 955,-	180.4	0.910	17	LAN6L+LAU11L+LAN4L+LAV70L +LA13L+LAN1P+2xNL41
A LAV1421L	2742	1755	1628	838	1105	5 185,-	193.8	0.957	17	LAN2L+LA16L+LAV70L+LAN3P +LAU11L+LAN5P+2xNL41
B LAV1431L	2742	1755	1628	838	1105	5 185,-	193.8	0.957	17	LAN6L+LAU11L+LAN4L+LAV70L +LA16L+LAN1P+2xNL41

ADDITIONAL CHARGE

FEATURE	PRODUCT														COMMENTS
	LAV137L	LAV138L	LAV139L	LAV140L	LAV141L	LAV142L	LAV143L	LAV1401L	LAV1411L	LAV1421L	LAV1431L	kg	m <sup>3</sup>	pcs	
MONITOR SHELF x 1	160,-	160,-	160,-	160,-	160,-	160,-	160,-	160,-	160,-	160,-	160,-	0.1	0.0001	1	

DESCRIPTION

- NET WEIGHT

VOLUME

NUMBER OF PACKAGES

RECEPTION DESKS SYSTEMS

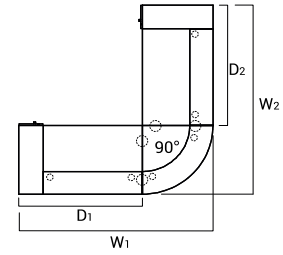
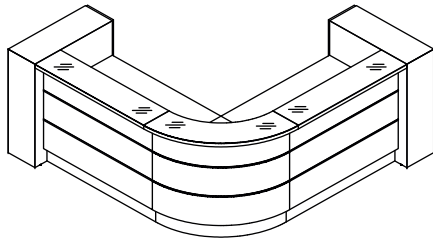

INDEX SYMBOL	DIMENSIONS [mm]					PRICE EUR				COMPONENTS
	W <sub>1</sub>	W <sub>2</sub>	D <sub>1</sub>	D <sub>2</sub>	H		kg	m <sup>3</sup>	pcs	
LAV146L	2525	2525	1608	1608	1105	6 110,-	263.7	1.684	18	LAD10+LAL10+LA13L+LAV70L +LA13L+LAP10+LAD10+2xNL41
LAV147L	2525	2825	1608	1908	1105	6 340,-	277.1	1.731	18	LAD10+LAL10+LA16L+LAV70L +LA13L+LAP10+LAD10+2xNL41
LAV148L	2525	3525	1608	2608	1105	6 895,-	303.6	1.855	19	LAD10+LAL10+LA23L+LAV70L +LA13L+LAP10+LAD10+2xNL41
LAV149L	2825	2525	1908	1608	1105	6 340,-	277.1	1.731	18	LAD10+LAL10+LA13L+LAV70L +LA16L+LAP10+LAD10+2xNL41
LAV150L	2825	2825	1908	1908	1105	6 570,-	290.5	1.778	18	LAD10+LAL10+LA16L+LAV70L +LA16L+LAP10+LAD10+2xNL41
LAV151L	2825	3525	1908	2608	1105	7 125,-	317.0	1.902	19	LAD10+LAL10+LA23L+LAV70L +LA16L+LAP10+LAD10+2xNL41

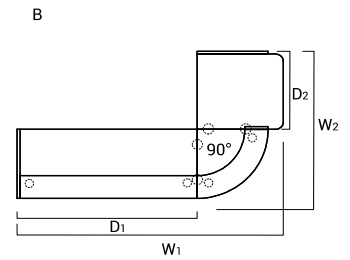
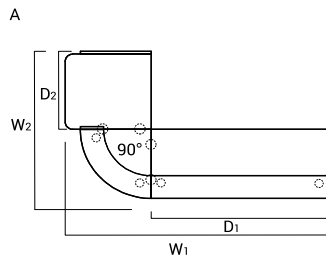
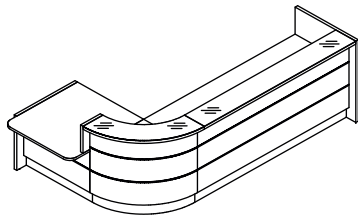

INDEX SYMBOL	DIMENSIONS [mm]					PRICE EUR				COMPONENTS
	W <sub>1</sub>	W <sub>2</sub>	D <sub>1</sub>	D <sub>2</sub>	H		kg	m <sup>3</sup>	pcs	
A LAV144L	3442	1955	2318	1038	1105	5 850,-	224.3	1.104	18	LAN2L+LA23L+LAV70L+LAN3P +LAU11L+LAN5P+2xNL41
B LAV145L	3442	1955	2318	1038	1105	5 850,-	224.3	1.104	18	LAN6L+LAU11L+LAN4L+LAV70L +LA23L+LAN1P+2xNL41
A LAV1441L	3442	1755	2318	838	1105	5 740,-	220.3	1.081	18	LAN2L+LA23L+LAV70L+LAN3P +LAU111L+LAN5P+2xNL41
B LAV1451L	3442	1755	2318	838	1105	5 740,-	220.3	1.081	18	LAN6L+LAU111L+LAN4L+LAV70L +LA23L+LAN1P+2xNL41

ADDITIONAL CHARGE

FEATURE	PRODUCT													COMMENTS
	LAV146L	LAV147L	LAV148L	LAV149L	LAV150L	LAV151L	LAV144L	LAV145L	LAV1441L	LAV1451L	kg	m <sup>3</sup>	pcs	
MONITOR SHELF x 1	160,-	160,-	160,-	160,-	160,-	160,-	160,-	160,-	160,-	160,-	0.1	0.0001	1	
MONITOR SHELF x 2	320,-	320,-	320,-	320,-	320,-	320,-					0.9	0.0070	1	

DESCRIPTION

- NET WEIGHT

VOLUME

NUMBER OF PACKAGES

RECEPTION DESKS SYSTEMS

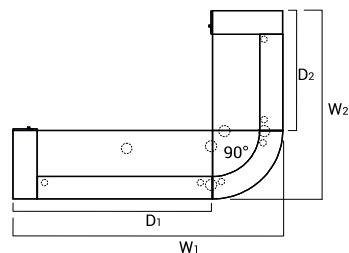
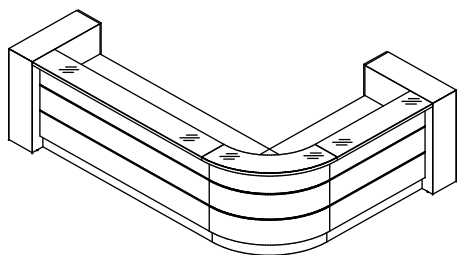

INDEX SYMBOL	DIMENSIONS [mm]					PRICE EUR				COMPONENTS
	W <sub>1</sub>	W <sub>2</sub>	D <sub>1</sub>	D <sub>2</sub>	H		kg	m <sup>3</sup>	pcs	
LAV152L	3525	2525	2608	1608	1105	6 895,-	303.6	1.855	19	LAD10+LAL10+LA13L+LAV70L +LA23L+LAP10+LAD10+2xNL41
LAV153L	3525	2825	2608	1908	1105	7 125,-	317.0	1.902	19	LAD10+LAL10+LA16L+LAV70L +LA23L+LAP10+LAD10+2xNL41
LAV154L	3525	3525	2608	2608	1105	7 680,-	343.5	2.027	20	LAD10+LAL10+LA23L+LAV70L +LA23L+LAP10+LAD10+2xNL41

ADDITIONAL CHARGE

FEATURE	PRODUCT													COMMENTS
	LAV152L	LAV153L	LAV154L								kg	m <sup>3</sup>	pcs	
MONITOR SHELF x 1	160,-	160,-	160,-								0.1	0.0001	1	
MONITOR SHELF x 2	320,-	320,-	320,-								0.9	0.0070	1	

DESCRIPTION

- NET WEIGHT

VOLUME

NUMBER OF PACKAGES

RECEPTION DESKS SYSTEMS

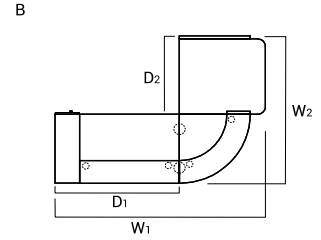
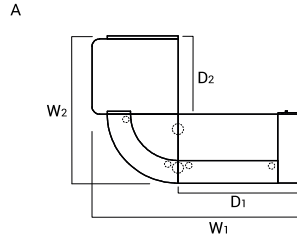
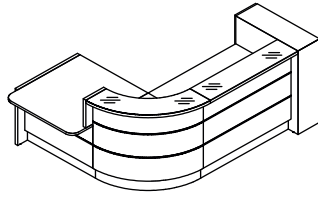

INDEX SYMBOL	DIMENSIONS [mm]					PRICE EUR				COMPONENTS
	W <sub>1</sub>	W <sub>2</sub>	D <sub>1</sub>	D <sub>2</sub>	H		kg	m <sup>3</sup>	pcs	
A LAV155L	2722	1955	1608	1038	1105	5 445,-	209.9	1.251	17	LAD10+LAL10+LA13L+LAV70L+LAN3P+LAU11L+LAN5P+2xNL41
B LAV156L	2722	1955	1608	1038	1105	5 445,-	214.4	1.262	18	LAN6L+LAU11L+LAN4L+LAV70L+LA13L+LAP10+LAD10+2xNL41
A LAV157L	3022	1955	1908	1038	1105	5 675,-	223.3	1.299	17	LAD10+LAL10+LA16L+LAV70L+LAN3P+LAU11L+LAN5P+2xNL41
B LAV158L	3022	1955	1908	1038	1105	5 675,-	223.3	1.299	17	LAN6L+LAU11L+LAN4L+LAV70L+LA16L+LAP10+LAD10+2xNL41
A LAV159L	3722	1955	2608	1038	1105	6 230,-	249.8	1.423	18	LAD10+LAL10+LA23L+LAV70L+LAN3P+LAU11L+LAN5P+2xNL41
B LAV160L	3722	1955	2608	1038	1105	6 230,-	249.8	1.423	18	LAN6L+LAU11L+LAN4L+LAV70L+LA23L+LAP10+LAD10+2xNL41
A LAV1551L	2722	1755	1608	838	1105	5 335,-	205.9	1.228	17	LAD10+LAL10+LA13L+LAV70L+LAN3P+LAU11L+LAN5P+2xNL41
B LAV1561L	2722	1755	1608	838	1105	5 335,-	210.4	1.239	18	LAN6L+LAU11L+LAN4L+LAV70L+LA13L+LAP10+LAD10+2xNL41
A LAV1571L	3022	1755	1908	838	1105	5 565,-	219.3	1.275	17	LAD10+LAL10+LA16L+LAV70L+LAN3P+LAU11L+LAN5P+2xNL41
B LAV1581L	3022	1955	1908	838	1105	5 565,-	215.3	1.269	17	LAN6L+LAU11L+LAN4L+LAV70L+LA16L+LAP10+LAD10+2xNL41
A LAV1591L	3722	1755	2608	838	1105	6 120,-	245.8	1.400	18	LAD10+LAL10+LA23L+LAV70L+LAN3P+LAU11L+LAN5P+2xNL41
B LAV1601L	3722	1755	2608	838	1105	6 120,-	245.8	1.400	18	LAN6L+LAU11L+LAN4L+LAV70L+LA23L+LAP10+LAD10+2xNL41

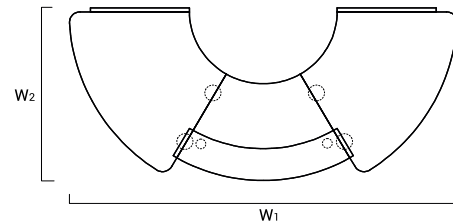
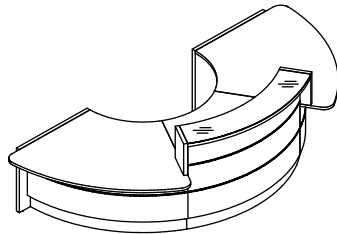

INDEX SYMBOL	DIMENSIONS [mm]					PRICE EUR				COMPONENTS
	W <sub>1</sub>	W <sub>2</sub>	D <sub>1</sub>	D <sub>2</sub>	H		kg	m <sup>3</sup>	pcs	
LAV05L	3589	1629	-	-	1105	5 515,-	224.1	1.781	17	LAN6L+2xLAV66L+LAN4L+LAV64L+LAN3P+LAN5P+2xNL41

ADDITIONAL CHARGE

FEATURE	PRODUCT																COMMENTS
	LAV155L	LAV156L	LAV157L	LAV158L	LAV159L	LAV160L	LAV1551L	LAV1561L	LAV1571L	LAV1581L	LAV1591L	LAV1601L	LAV05L	kg	m <sup>3</sup>	pcs	
MONITOR SHELF x 1	160,-	160,-	160,-	160,-	160,-	160,-	160,-	160,-	160,-	160,-	160,-	160,-	160,-	0.1	0.0001	1	

DESCRIPTION

- NET WEIGHT

VOLUME

NUMBER OF PACKAGES

RECEPTION DESKS SYSTEMS

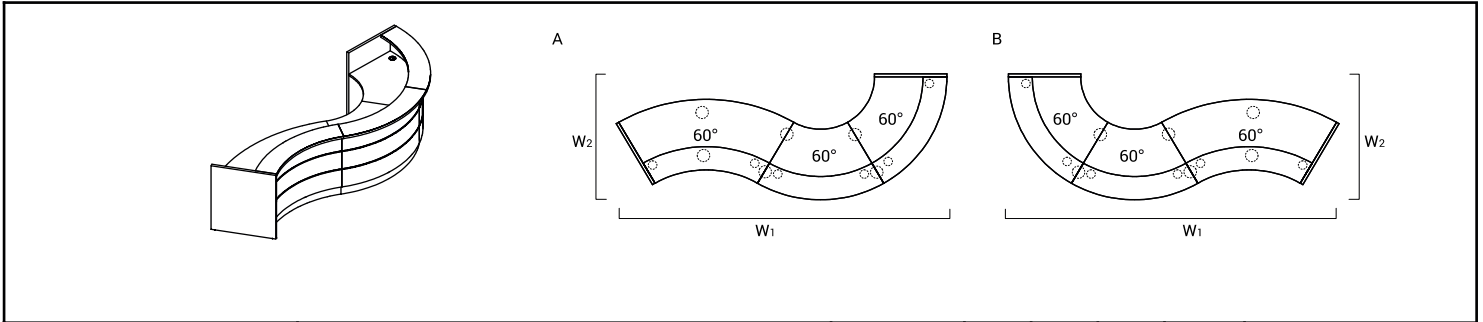

INDEX SYMBOL	DIMENSIONS [mm]					PRICE EUR				COMPONENTS
	W <sub>1</sub>	W <sub>2</sub>	D <sub>1</sub>	D <sub>2</sub>	H		kg	m <sup>3</sup>	pcs	
A <b>LAV06L</b>	4199	1629	-	-	1105	6 975,-	269.5	2.345	20	LAN2L+2xLAV64L+LAV62L+LAN1P+2xNL41
B <b>LAV07L</b>	4199	1629	-	-	1105	6 975,-	269.5	2.345	20	LAN2L+LAV62L+2xLAV64L+LAN1P+2xNL41

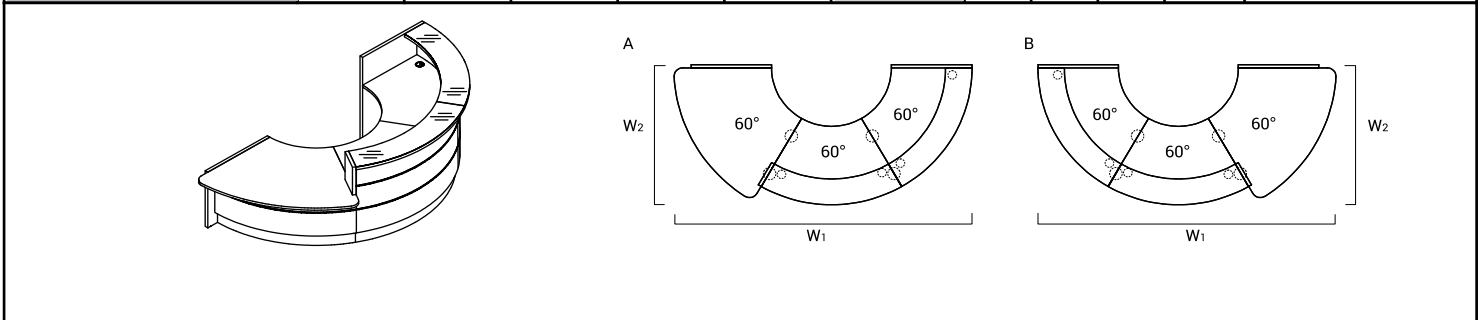

INDEX SYMBOL	DIMENSIONS [mm]					PRICE EUR				COMPONENTS
	W <sub>1</sub>	W <sub>2</sub>	D <sub>1</sub>	D <sub>2</sub>	H		kg	m <sup>3</sup>	pcs	
A <b>LAV08L</b>	3367	1629	-	-	1105	6 220,-	235.3	2.009	16	LAN2L+2xLAV64L+LAN3P+LAV66L+LAN5P+2xNL41
B <b>LAV09L</b>	3367	1629	-	-	1105	6 220,-	235.3	2.009	16	LAN6L+LAV66L+LAN4L+2xLAV64L+LAN1P+2xNL41

ADDITIONAL CHARGE

FEATURE	PRODUCT													COMMENTS
	LAV06L	LAV07L	LAV08L	LAV09L							kg	m <sup>3</sup>	pcs	
MONITOR SHELF x 1	160,-	160,-	160,-	160,-							0.1	0.0001	1	
MONITOR SHELF x 2	320,-	320,-	320,-	320,-							0.9	0.0070	1	
MONITOR SHELF x 3	480,-	480,-									0.9	0.0070	1	

DESCRIPTION

- NET WEIGHT

VOLUME

NUMBER OF PACKAGES

RECEPTION DESKS SYSTEMS

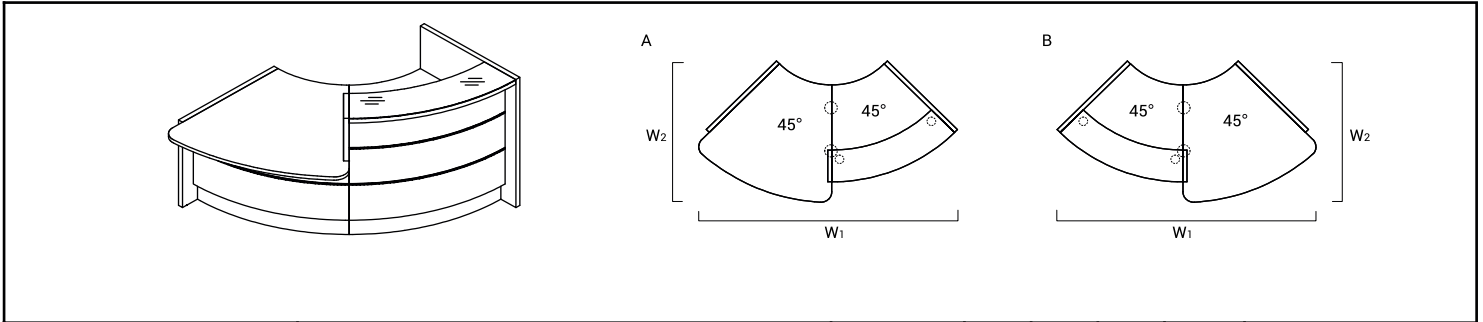

INDEX SYMBOL	DIMENSIONS [mm]					PRICE EUR				COMPONENTS
	W <sub>1</sub>	W <sub>2</sub>	D <sub>1</sub>	D <sub>2</sub>	H		kg	m <sup>3</sup>	pcs	
A <b>LAV161L</b>	2320	1114	-	-	1105	3 560,-	138.8	0.950	11	LAN2L+LAV63L+LAN3P+LAV65L+LAN5P+NL41
B <b>LAV162L</b>	2320	1114	-	-	1105	3 560,-	138.8	0.950	11	LAN6L+LAV65L+LAN4L+LAV63L+LAN1P+NL41

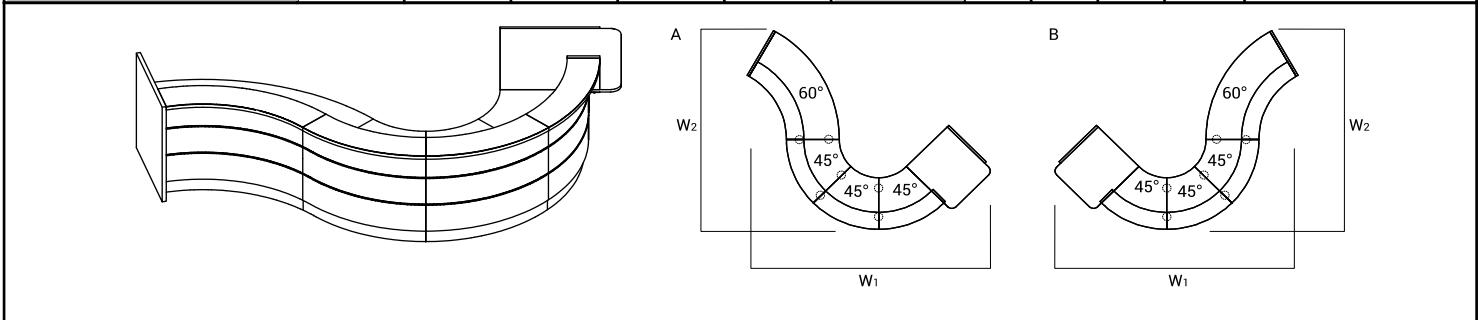

INDEX SYMBOL	DIMENSIONS [mm]					PRICE EUR				COMPONENTS
	W <sub>1</sub>	W <sub>2</sub>	D <sub>1</sub>	D <sub>2</sub>	H		kg	m <sup>3</sup>	pcs	
A <b>LAV163L</b>	4080	3540	-	-	1105	9 695,-	324.8	2.672	26	LAN6L+LAU111L+LAN4L+3xLAV63L+LAV62L+LAN1P+4xNL41
B <b>LAV164L</b>	4080	3540	-	-	1105	9 695,-	324.8	2.672	26	LAN2L+LAV62L+3xLAV63L+LAN3P+LAU111L+LAN5P+4xNL41
A <b>LAV1631L</b>	4080	3540	-	-	1105	9 585,-	320.8	2.649	26	LAN6L+LAU111L+LAN4L+3xLAV63L+LAV62L+LAN1P+4xNL41
B <b>LAV1641L</b>	4080	3540	-	-	1105	9 585,-	320.8	2.649	26	LAN2L+LAV62L+3xLAV63L+LAN3P+LAU111L+LAN5P+4xNL41

ADDITIONAL CHARGE

FEATURE	PRODUCT									COMMENTS
	LAV163L	LAV164L	LAV1631L	LAV1641L			kg	m <sup>3</sup>	pcs	
MONITOR SHELF x 1	160,-	160,-	160,-	160,-			0.1	0.0001	1	

DESCRIPTION

- NET WEIGHT

VOLUME

NUMBER OF PACKAGES

RECEPTION DESKS SYSTEMS

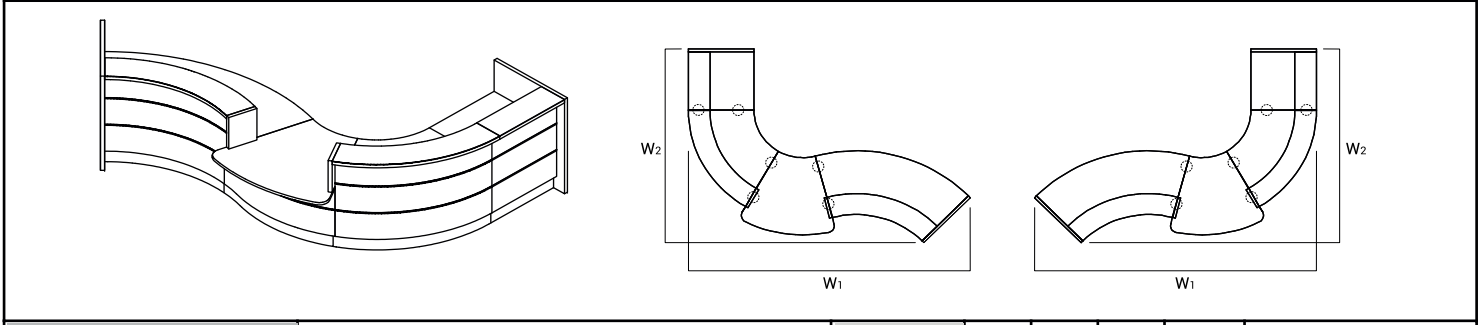

INDEX SYMBOL	DIMENSIONS [mm]					PRICE EUR				COMPONENTS
	W <sub>1</sub>	W <sub>2</sub>	D <sub>1</sub>	D <sub>2</sub>	H		kg	m <sup>3</sup>	pcs	
LAV165L	2677	3946	-	-	1105	7 060,-	297.1	2.069	25	LAN2L+LAV62L+LAN3P+LAV65L +LAN4L+LAV63L+LA09L+LAN1P +3xNL41

ADDITIONAL CHARGE

FEATURE	PRODUCT													COMMENTS
	LAV165L										kg	m <sup>3</sup>	pcs	
MONITOR SHELF x 1	160,-										0.1	0.0001	1	

DESCRIPTION

- NET WEIGHT

VOLUME

NUMBER OF PACKAGES



PRODUCT ILLUSTRATION	DIMENSIONS [mm]			INDEX SYMBOL	PRICE EUR				COMMENTS
	WIDTH	DEPTH	HEIGHT			kg	m3	pcs	

**STRAIGHT ELEMENTS**

	844	917	1105	<b>LA09L</b>	1 125,-	36.0	0.149	4	
	1290	917	1105	<b>LA13L</b>	1 420,-	53.6	0.223	4	
	1590	917	1105	<b>LA16L</b>	1 650,-	67.0	0.270	4	
	2290	917	1105	<b>LA23L</b>	2 205,-	93.5	0.395	5	worktop with support leg NE41, M015 - white semi-matte
	1290	917	1105	<b>LAP13L</b>	1 420,-	52.6	0.223	4	
	1590	917	1105	<b>LAP16L</b>	1 650,-	66.5	0.270	4	
	2290	917	1105	<b>LAP23L</b>	2 205,-	93.0	0.395	5	worktop with support leg NE41, M015 - white semi-matte
	1290	917	1105	<b>LAL13L</b>	1 420,-	52.6	0.223	4	
	1590	917	1105	<b>LAL16L</b>	1 650,-	66.5	0.270	4	

**ADDITIONAL CHARGE**



FEATURE	PRODUCT												COMMENTS
	LA13L	LA16L	LA23L	LAP13L	LAP16L	LAP23L	LAL13L	LAL16L		kg	m3	pcs	
MONITOR SHELF x 1	160,-	160,-	160,-	160,-	160,-	160,-	160,-	160,-	160,-	0.1	0.0001	1	

DESCRIPTION

- NET WEIGHT

VOLUME



NUMBER OF PACKAGES

PRODUCT ILLUSTRATION	DIMENSIONS [mm]			INDEX SYMBOL	PRICE EUR				COMMENTS
	WIDTH	DEPTH	HEIGHT			kg	m3	pcs	

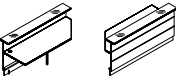
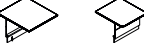
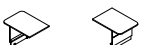
**STRAIGHT ELEMENTS**

	2290	917	1105	LAL23L	2 205,-	93.0	0.395	5	worktop with support leg NE41, M015 - white semi - matte
	1000	1114	740	LAU11L	1 105,-	32.5	0.123	3	
	800	1114	740	LAU111L	995,-	28.5	0.100	3	

**ADDITIONAL CHARGE**



FEATURE	PRODUCT												COMMENTS
	LAL23L									kg	m3	pcs	
MONITOR SHELF x 1	160,-									0.1	0.0001	1	

DESCRIPTION







 - NET WEIGHT

 VOLUME

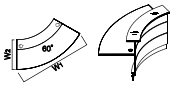

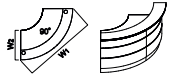
 NUMBER OF PACKAGES

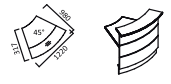
PRODUCT ILLUSTRATION	DIMENSIONS [mm]			INDEX SYMBOL	PRICE EUR				COMMENTS
	WIDTH	DEPTH	HEIGHT			kg	m3	pcs	

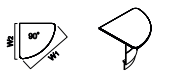
**RADIAL ELEMENTS**

	2216	917	1105	LAV62L	2 205,-	75.5	0.758	5	worktop with support leg NL41, M015 - white semi - matte
	1600	917	1105	LAV64L	2 155,-	64.5	0.671	4	
	2264	917	1105	LAV90L	2 785,-	105.5	1.043	5	
	1297	917	1105	LAV70L	2 050,-	43.5	0.361	4	
	1225	917	1105	LAV63L	1 945,-	53.5	0.502	4	
	1311	1165	740	LAV65L	1 155,-	35.5	0.291	3	
	1720	1109	740	LAV66L	1 420,-	54.5	0.446	3	
	1485	1109	740	LAV68L	1 365,-	35.5	0.260	3	

**ADDITIONAL CHARGE**



FEATURE	PRODUCT												COMMENTS
	LAV62L	LAV64L	LAV90L							kg	m3	pcs	
MONITOR SHELF x 1	160,-	160,-	160,-							0.1	0.0001	1	

DESCRIPTION



 - NET WEIGHT

 VOLUME



 NUMBER OF PACKAGES

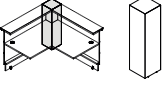
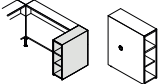
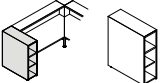
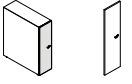
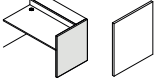
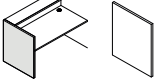
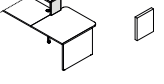

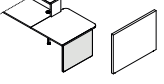
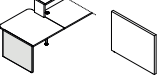
PRODUCT ILLUSTRATION	DIMENSIONS [mm]			INDEX SYMBOL	PRICE EUR					COMMENTS
	WIDTH	DEPTH	HEIGHT			kg	m3	pcs		

## COMPOSITION ELEMENTS







	300	300	1105	<b>LA100</b>	265,-	22.2	0.115	1		corner unit
	318	917	1105	<b>LAP10</b>	495,-	50.0	0.364	1		end unit with cupboard - right
	318	917	1105	<b>LAL10</b>	495,-	50.0	0.364	1		end unit with cupboard - left
	306	20	1094	<b>LAD10</b>	85,-	4.5	0.011	1		universal door for LAP10 and LAL10
	38	917	1105	<b>LAN1P</b>	200,-	26.0	0.051	1		side panel for high units - right
	38	917	1105	<b>LAN2L</b>	200,-	26.0	0.051	1		side panel for high units -left
	38	300	364	<b>LAN3P</b>	70,-	2.8	0.007	1		right upper side panel for combining low and high element
	38	300	364	<b>LAN4L</b>	70,-	2.8	0.007	1		left upper side panel for combining low and high element
	38	917	740	<b>LAN5P</b>	160,-	19.0	0.036	1		right side panel for low unit
	38	917	740	<b>LAN6L</b>	160,-	19.0	0.036	1		left side panel for low unit

DESCRIPTION

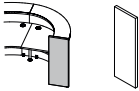
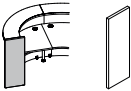
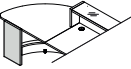
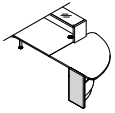

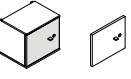
 - NET WEIGHT VOLUME NUMBER OF PACKAGES

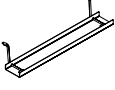
PRODUCT ILLUSTRATION	DIMENSIONS [mm]			INDEX SYMBOL	PRICE EUR					COMMENTS
	WIDTH	DEPTH	HEIGHT			kg	m3	pcs		

## COMPOSITION ELEMENTS

	38	374	1105	<b>LAN7P</b>	105,-	11.0	0.024	1		right side panel for high unit
	38	374	1105	<b>LAN8L</b>	105,-	11.0	0.024	1		left side panel for high unit
	38	374	740	<b>LAN9L</b>	85,-	7.5	0.013	1		
	38	374	740	<b>LAN9P</b>	85,-	7.5	0.013	1		
	345	283	314	<b>LMS05</b>	180,-	5.0	0.031	1		
	339	18	286	<b>LMS06</b>	60,-	2.0	0.005	1		
	585	142	712	<b>NL41</b>	30,-	2.0	0.063	1		round profile leg
	40	40	712	<b>NE41L</b>	30,-	1.5	0.002	1		round profile leg
	460	89	120	<b>E64L</b>	32,-	0.5	0.001	1		horizontal cable tray M009 - aluminum semi - matte
	580	162	123	<b>S69L</b>	25,-	1.0	0.015	1		09 - aluminum
	140	70	750	<b>S81L</b>	50,-	1.1	0.008	1		vertical cable duct in colour 09-aluminum

DESCRIPTION

 - NET WEIGHT VOLUME NUMBER OF PACKAGES

TECHNICAL SPECIFICATION

COLOURS

BODY



34 CHESTNUT



67 WHITE PASTEL



FRONT HPL

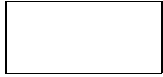

73 HIGH GLOSS  
WHITE



74 HIGH GLOSS  
ORANGE



80 HIGH GLOSS  
LIME



81 HIGH GLOSS  
BURGUNDY

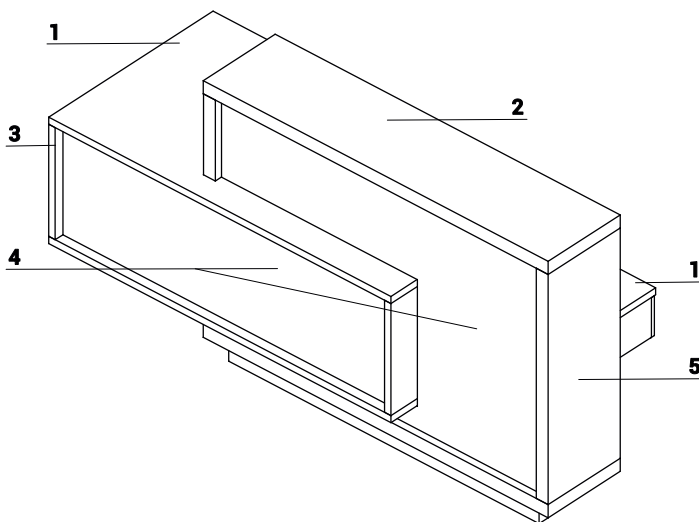
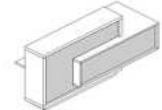

- 1. **Worktop** - MFC 28mm, PVC edge
- 2. **Top** - MFC 52mm(12+12+28mm), PVC edge
- 3. **Body** - MFC 28mm, PVC edge
- 4. **Front** - HPL 18mm - high gloss, PVC edge
- 5. **Body** - MFC 52mm, PVC edge

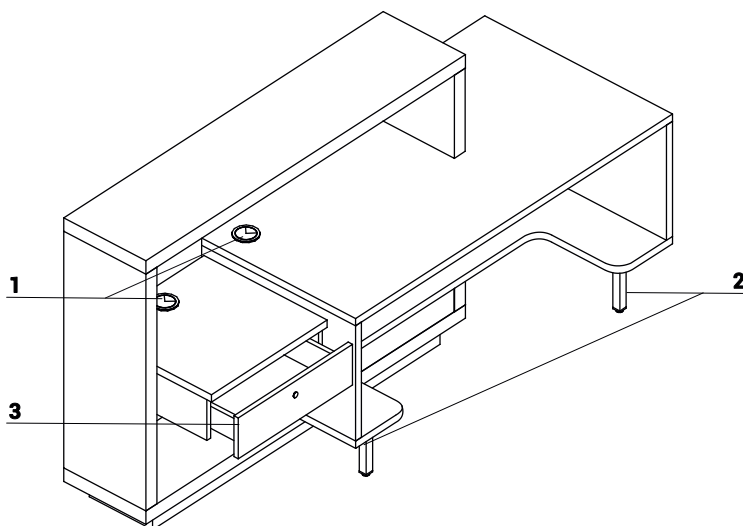

- 1. **Cable grommets** - Ø80mm
- 2. **Supporting leg** - profile 30x30mm, color M009 - aluminum semi-matte
- 3. **MFC drawer** - ball runners, capacity 40kg, 80% pull-out, patent lock

ATTENTION - Interior of the front in white

TECHNICAL SPECIFICATION

DIMENSIONS

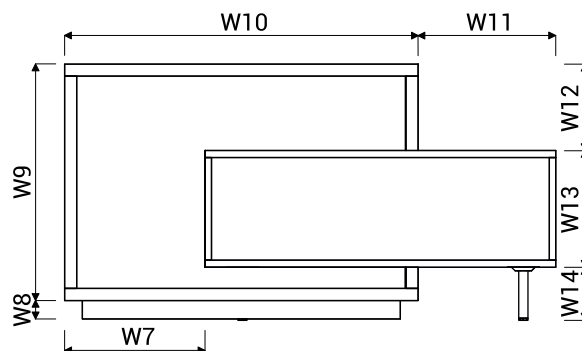
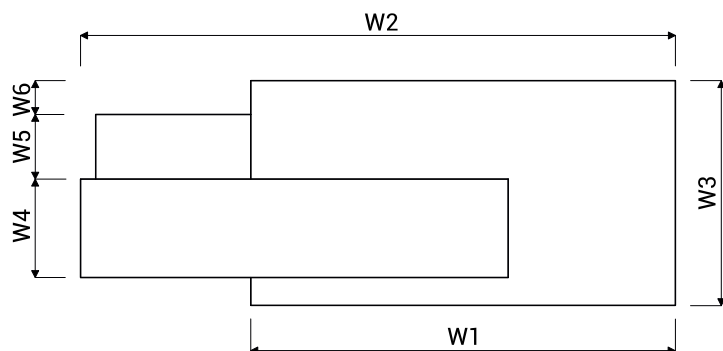

W1 - 1500mm | W2 - 2101mm | W3 - 800mm | W4 - 350mm | W5 - 231mm | W6 - 121mm | W7 - 600mm | W8 - 80mm | W9 - 1016mm | W10 - 1512mm | W11 - 589mm | W12 - 372mm | W13 - 500mm | W14 - 230mm

PRODUCT ILLUSTRATION	DIMENSIONS [mm]			INDEX SYMBOL	PRICE EUR	kg	m3	pcs		COMMENTS
	WIDTH	DEPTH	HEIGHT							

FORO RECEPTION DESK

	2100	800	1100	LF10	1 890,-	171.3	0.447	4		
	2100	800	1100	LF11	1 890,-	171.3	0.454	4		

DESCRIPTION

- NET WEIGHT

VOLUME

NUMBER OF PACKAGES

## TECHNICAL SPECIFICATION

## COLOURS

## ZEN

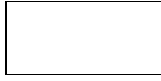
26 ALUMINUM  
SATINATO

67 WHITE PASTEL

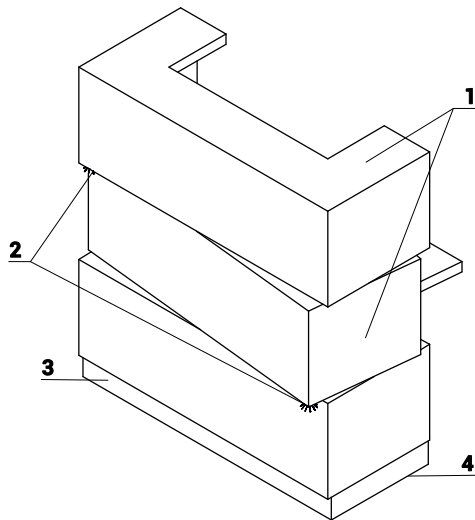

1. **Top and front** - HPL - mat
2. **LED illumination** - at the full length of the reception desk, cold white colour (verging on the blue shade)
3. **Kick plate** - HPL - brushed aluminum
4. **Leveling** - 10mm range

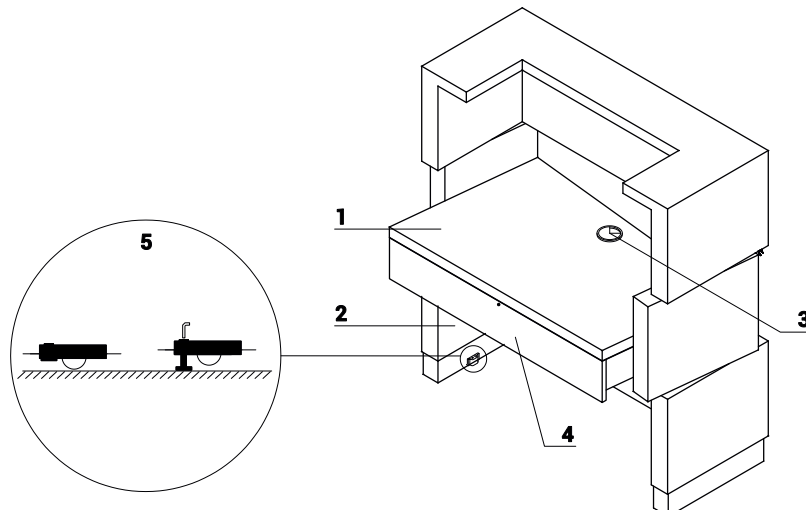

1. **Worktop** - MFC 28mm; possible heights : 680mm, 720mm, 830mm
2. **Reception interior** - MFC, colour 67 - white pastel
3. **Cable grommets** - Ø80mm
4. **Option with additional charge** - Drawer with lock
5. **Optional foot with wheels** - additional charge - 4pcs in a set (max. Load for 1 wheel 120kg, max load for 1 foot 200kg )



## TECHNICAL SPECIFICATION

## DIMENSIONS

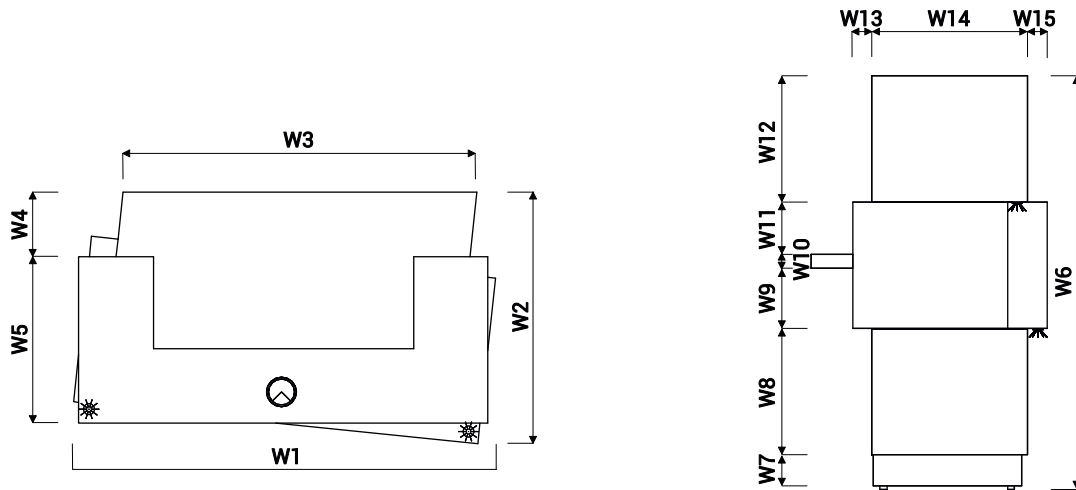

W1 - 1134mm | W2 - 680mm | W3 - 952mm | W4 - 173mm | W5 - 450mm | W6 - 1199mm | W7 - 89mm | W8 - 368mm | W9 - 226mm | W10 - 28mm |  
 W11 - 113mm | W12 - 368mm | W13 - 55mm | W14 - 450mm | W15 - 57mm

PRODUCT ILLUSTRATION	DIMENSIONS [mm]			INDEX SYMBOL	PRICE EUR				COMMENTS
	WIDTH	DEPTH	HEIGHT			kg	m3	pcs	

## ZEN RECEPTION DESK

	1135	680	1200	<b>LZE10</b>	1 890,-	100.5	0.900	2	
	948	493	160	<b>LZS01</b>	125,-	13.0	0.090	1	

## ADDITIONAL CHARGE

FEATURE	PRODUCT											COMMENTS
	LZE10								kg	m3	pcs	
FEET WITH CASTORS	180,-								1.0	0.0010	1	

## DESCRIPTION

- NET WEIGHT

VOLUME

NUMBER OF PACKAGES

TECHNICAL SPECIFICATION

COLOURS

FRONT



34 CHESTNUT



64 COCOA



BODY

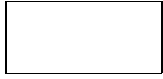

67 WHITE PASTEL

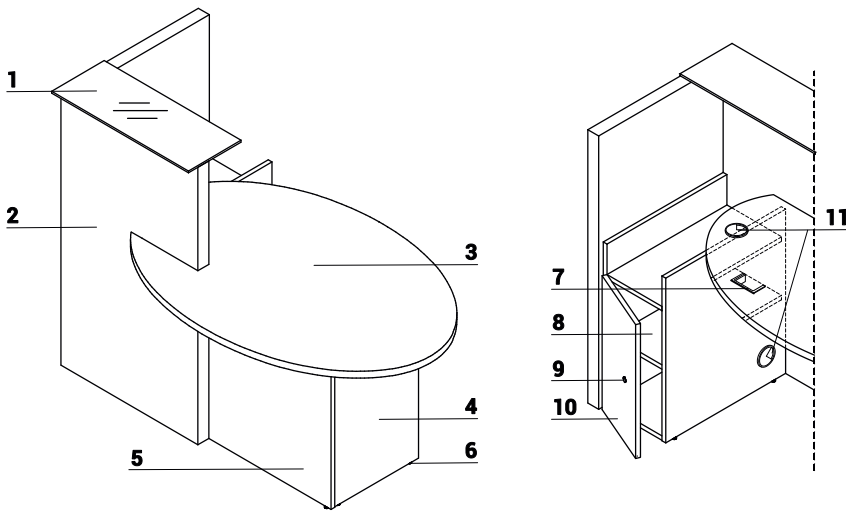
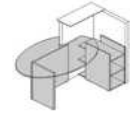

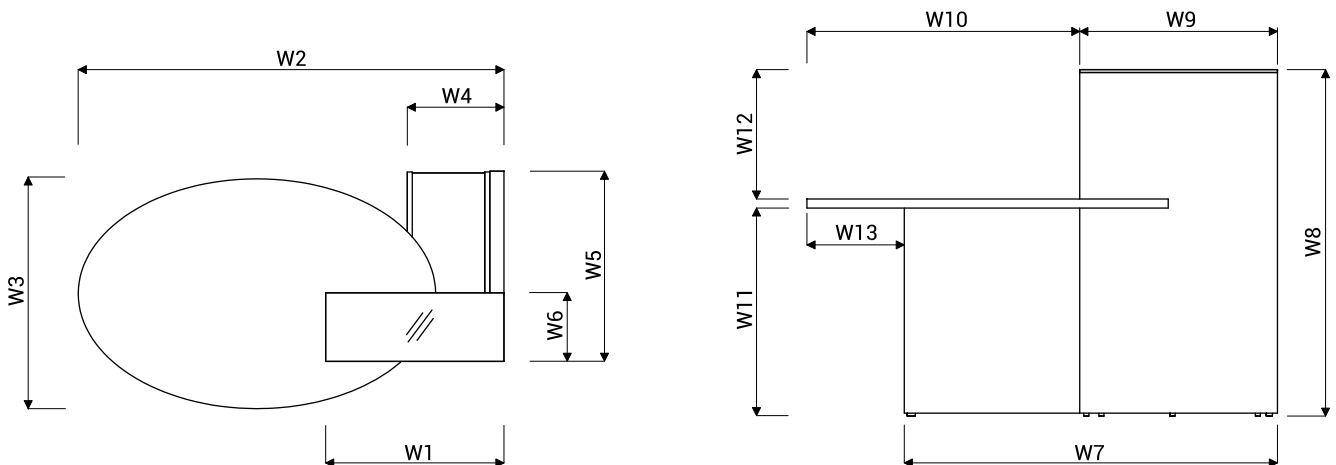

- 1. Top - tempered frosted glass 8mm
- 2. Front - MFC 52mm
- 3. Worktop - MFC 28mm, PVC edge
- 4. Body - MFC 28mm, PVC edge
- 5. Body - MFC 18mm, PVC edge
- 6. Leveling - 5mm range
- 7. Rectangular grommet- 90x48mm
- 8. Dividing storage - MFC 18mm, PVC edge
- 9. Patent lock
- 10. Front - MFC 18mm, PVC edge
- 11. Cable grommets - Ø80mm

DIMENSIONS



W1 - 650mm | W2 - 1548mm | W3 - 870mm | W4 - 352mm | W5 - 695mm | W6 - 250mm | W7 - 1230mm | W8 - 1150mm | W9 - 650mm | W10 - 900mm | W11 - 692mm | W12 - 430mm | W13 - 320mm

PRODUCT ILLUSTRATION	DIMENSIONS [mm]			INDEX SYMBOL	PRICE EUR				COMMENTS
	WIDTH	DEPTH	HEIGHT			kg	m3	pcs	

**OVO RECEPTION DESK**

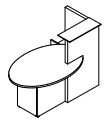
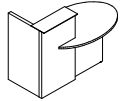
	1550	870	1150	<b>LOP10</b>	1 040,-	93.0	0.240	3	
	1550	870	1150	<b>LOL10</b>	1 040,-	93.0	0.236	3	

DESCRIPTION

 - NET WEIGHT

 VOLUME

 NUMBER OF PACKAGES

TECHNICAL SPECIFICATION

COLOURS

BODY, FRONT, COUNTER TOP



31 CANADIAN OAK

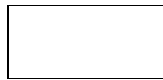

67 WHITE PASTEL



106 LOWLAND NUT

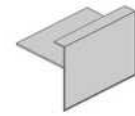

HPL ELEMENTS STRUCTURE



31 CANADIAN OAK



67 WHITE PASTEL



106 LOWLAND NUT

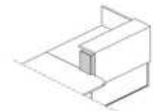
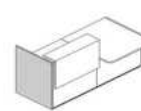

CORNER UNIT

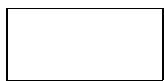

73 HIGH GLOSS WHITE



101 HIGH GLOSS BLACK



155 ANTHRACITE HIGH GLOSS

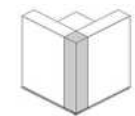

OPTIONAL TOP ELEMENT WITH LIGHT



73 HIGH GLOSS WHITE



WHITE, LACOBEL



101 HIGH GLOSS BLACK



BLACK, LACOBEL



155 ANTHRACITE HIGH GLOSS



ANTHRACITE, LACOBEL



SUPPORTING LEG WHERE WORKTOPS CONNECT NL41



M015 WHITE SEMI-MATTE

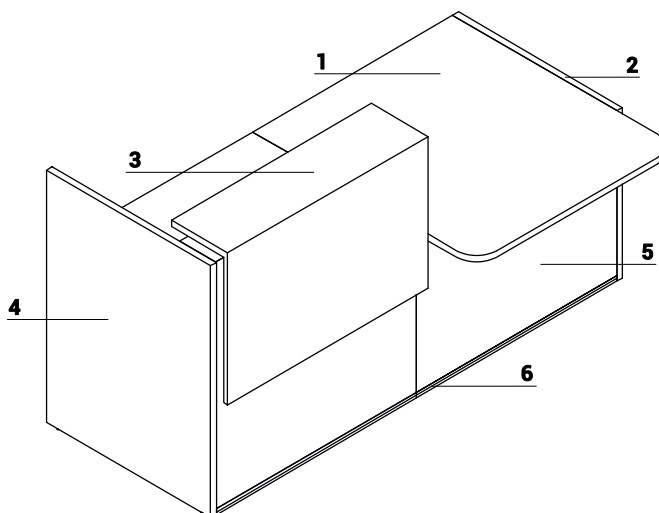

1. **Worktop** - MFC 28mm, PVC edge
2. **Low side panel** - MFC 28mm, PVC edge
3. **Optional top element with lightening** - top melamine board 28mm + Glass LACOBEL 4mm, front melamine board 18mm, all in HPL - gloss
4. **High side panel** - MFC 28mm, PVC edge
5. **Front** - MFC 18mm, PVC edge
6. **Decorative stripe** - PVC, colour: M009 - aluminum semi-matte

TECHNICAL SPECIFICATION

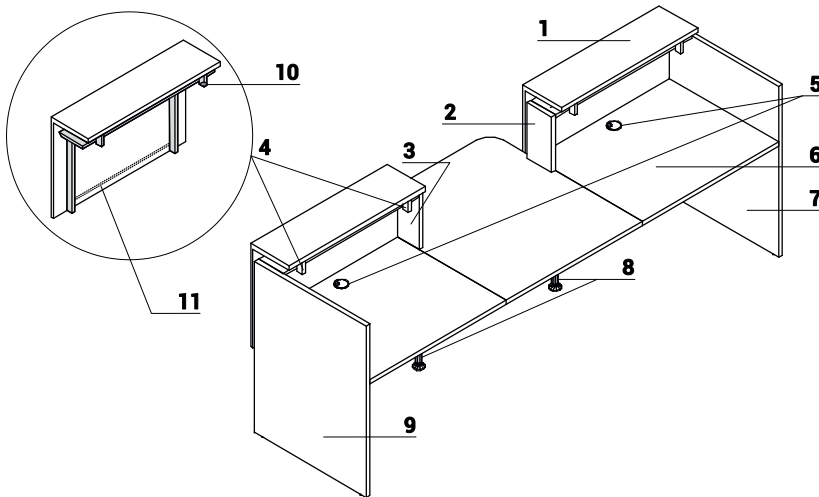

1. **Optional top element with lightening** - top melamine board 28mm + Glass LACOBEL 4mm, front melamine board 18mm, all in HPL - gloss
2. **Side panel linking low and high fronts** - MFC 28mm, PVC edge
3. **Side panel linking low and high fronts** - MFC 28mm, PVC edge
4. **Frame to optional top element with lightening** - metal powder - coated, white colour
5. **Cable grommets** - Ø80mm
6. **Worktop** - MFC 28mm, PVC edge
7. **High side panel** - MFC 28mm, PVC edge
8. **Supporting leg NL41**- required for connecting the tops
9. **High side panel** - MFC 28mm, PVC edge
10. **Light switch**
11. **LED lighting** - over the entire length of the extension, cold white (bluish kind of white)

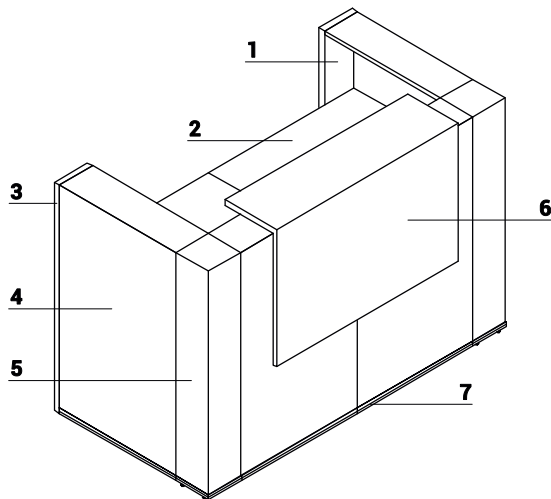

1. **High side panel** - MFC 28mm, PVC edge
2. **Worktop** - MFC 28mm, PVC edge
3. **High side panel** - MFC 28mm, PVC edge
4. **Front** - MFC 18mm, PVC edge
5. **Corner unit** - melamine board covered with HPL - gloss
6. **Optional top element with lightening** - top melamine board 28mm + Glass LACOBEL 4mm, front melamine board 18mm, all in HPL - gloss
7. **Decorative stripe** - PVC, colour: M009 - aluminum semi-matte

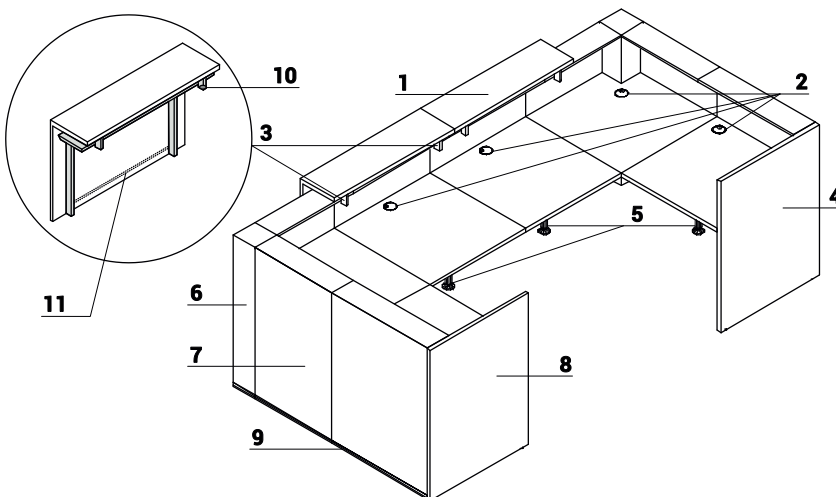

1. **Optional top element with lightening** - top melamine board 28mm + Glass LACOBEL 4mm, front melamine board 18mm, all in HPL - gloss
2. **Cable grommets** - Ø80mm
3. **Frame to optional top element with lightening** - metal powder - coated, white colour
4. **High side panel** - MFC 28mm, PVC edge
5. **Supporting leg NL41**- required for connecting the tops
6. **Corner unit** - melamine board covered with HPL - gloss
7. **Front** - MFC 18mm, PVC edge
8. **High side panel** - MFC 28mm, PVC edge
9. **Decorative stripe** - PVC, colour: M009 - aluminum semi-matte
10. **Light switch**
11. **LED lighting** - over the entire length of the extension, cold white (bluish kind of white)

TECHNICAL SPECIFICATION

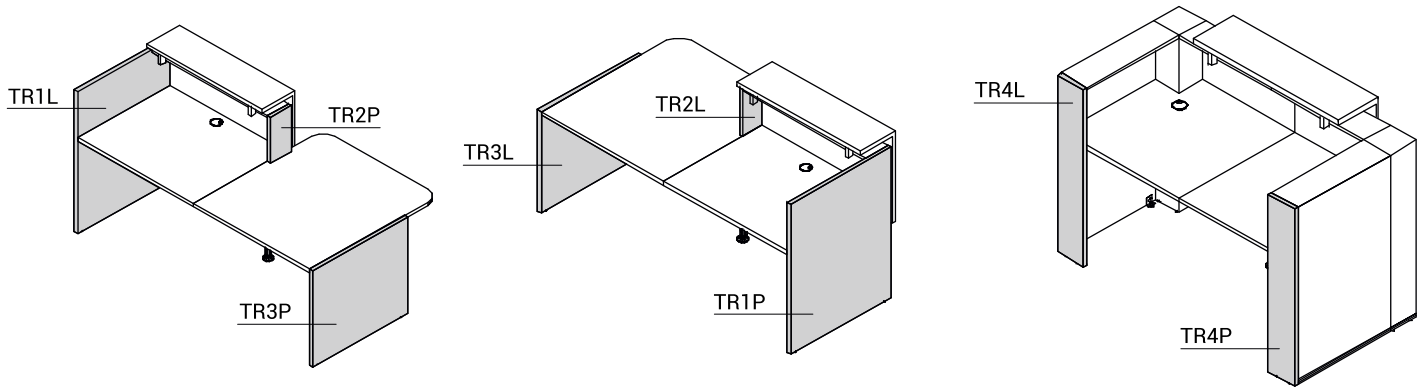

DIMENSIONS

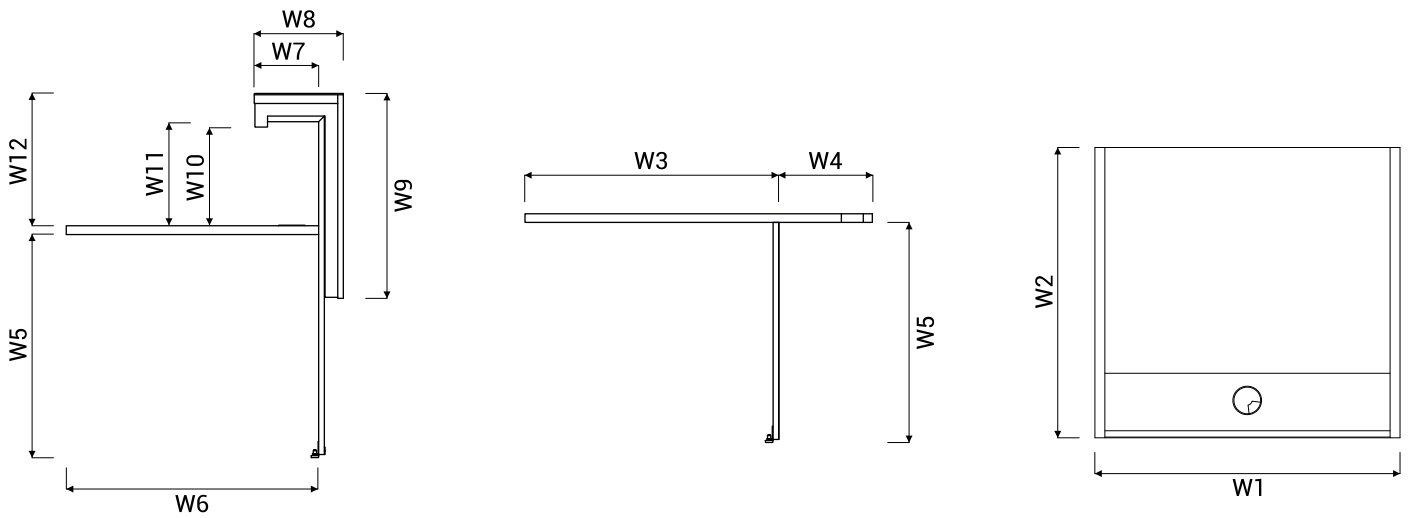

W1 - 856mm | W2 - 820mm | W3 - 818mm | W4 - 302mm | W5 - 740mm | W6 - 800mm | W7 - 205mm | W8 - 282mm | W9 - 650mm | W10 - 315mm | W11 - 322mm | W12 - 419mm

RECEPTION DESKS SYSTEMS

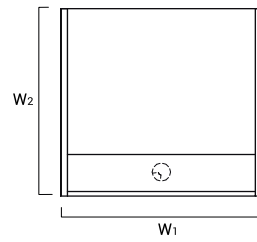
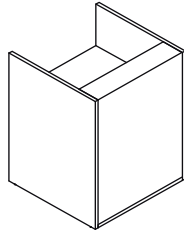

INDEX SYMBOL	DIMENSIONS [mm]					PRICE EUR				COMPONENTS
	W <sub>1</sub>	W <sub>2</sub>	D <sub>1</sub>	D <sub>2</sub>	H		kg	m <sup>3</sup>	pcs	
<b>TRA13</b>	856	820	-	-	1090	415,-	59.0	0.124	3	TR1L+TR08+TR1P

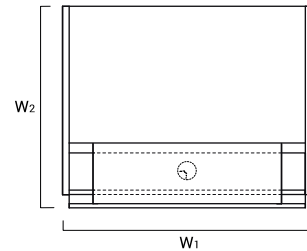
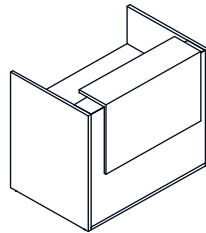

INDEX SYMBOL	DIMENSIONS [mm]					PRICE EUR				COMPONENTS
	W <sub>1</sub>	W <sub>2</sub>	D <sub>1</sub>	D <sub>2</sub>	H		kg	m <sup>3</sup>	pcs	
<b>TRA14</b>	1056	877	-	-	1159	995,-	83.0	0.320	4	TR1L+TR10+TR99+TR1P
<b>TRA15</b>	1256	877	-	-	1159	1 010,-	87.0	0.332	4	TR1L+TR12+TR99+TR1P
<b>TRA16</b>	1456	877	-	-	1159	1 025,-	89.0	0.344	4	TR1L+TR14+TR99+TR1P

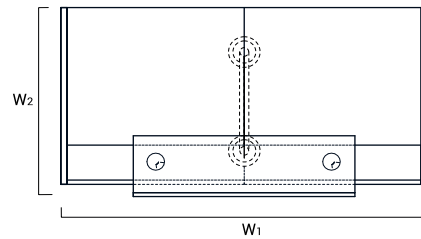
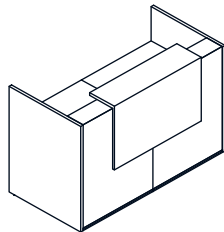

INDEX SYMBOL	DIMENSIONS [mm]					PRICE EUR				COMPONENTS
	W <sub>1</sub>	W <sub>2</sub>	D <sub>1</sub>	D <sub>2</sub>	H		kg	m <sup>3</sup>	pcs	
<b>TRA17</b>	1656	877	-	-	1159	1 250,-	103.0	0.425	6	TR1L+2xTR08+TR99+TR1P+NL41
<b>TRA18</b>	2056	877	-	-	1159	1 290,-	117.0	0.449	6	TR1L+2xTR10+TR99+TR1P+NL41
<b>TRA19</b>	2456	877	-	-	1159	1 320,-	125.0	0.473	6	TR1L+2xTR12+TR99+TR1P+NL41
<b>TRA20</b>	2856	877	-	-	1159	1 350,-	129.0	0.498	6	TR1L+2xTR14+TR99+TR1P+NL41

DESCRIPTION

- NET WEIGHT

VOLUME

NUMBER OF PACKAGES

RECEPTION DESKS SYSTEMS

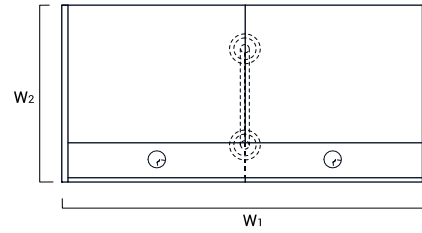
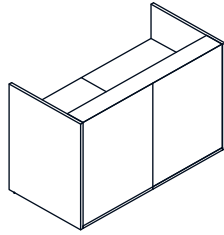

INDEX SYMBOL	DIMENSIONS [mm]					PRICE EUR				COMPONENTS
	W <sub>1</sub>	W <sub>2</sub>	D <sub>1</sub>	D <sub>2</sub>	H		kg	m <sup>3</sup>	pcs	
TRA117	1656	820	-	-	1090	690,-	86.0	0.242	5	TR1L+2xTR08+TR1P+NL41
TRA118	2056	820	-	-	1090	730,-	100.0	0.266	5	TR1L+2xTR10+TR1P+NL41
TRA119	2456	820	-	-	1090	760,-	108.0	0.290	5	TR1L+2xTR12+TR1P+NL41
TRA120	2856	820	-	-	1090	790,-	112.0	0.314	5	TR1L+2xTR14+TR1P+NL41

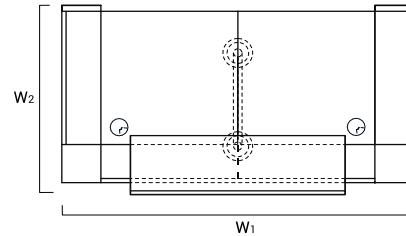
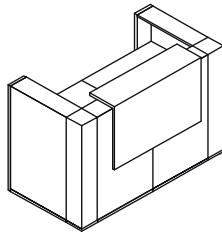

INDEX SYMBOL	DIMENSIONS [mm]					PRICE EUR				COMPONENTS
	W <sub>1</sub>	W <sub>2</sub>	D <sub>1</sub>	D <sub>2</sub>	H		kg	m <sup>3</sup>	pcs	
TRA42	1640	905	-	-	1159	1 620,-	99.0	0.460	8	TR4L+2xTR90+TR4P+TR99+NL41

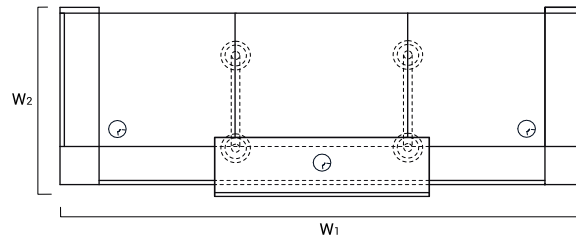
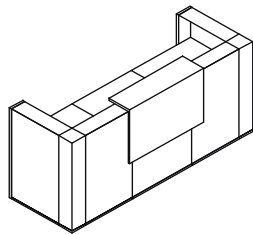

INDEX SYMBOL	DIMENSIONS [mm]					PRICE EUR				COMPONENTS
	W <sub>1</sub>	W <sub>2</sub>	D <sub>1</sub>	D <sub>2</sub>	H		kg	m <sup>3</sup>	pcs	
TRA21	2440	905	-	-	1159	1 895,-	126.0	0.577	10	TR4L+2xTR90+TR08+TR4P+TR99+2xNL41
TRA22	2640	905	-	-	1159	1 915,-	133.0	0.590	10	TR4L+2xTR90+TR10+TR4P+TR99+2xNL41
TRA23	2840	905	-	-	1159	1 930,-	137.0	0.602	10	TR4L+2xTR90+TR12+TR4P+TR99+2xNL41
TRA24	3040	905	-	-	1159	1 945,-	139.0	0.614	10	TR4L+2xTR90+TR14+TR4P+TR99+2xNL41

DESCRIPTION

- NET WEIGHT

VOLUME

NUMBER OF PACKAGES



RECEPTION DESKS SYSTEMS

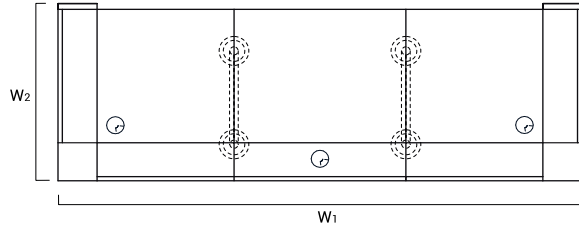
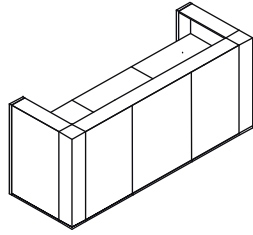

INDEX SYMBOL	DIMENSIONS [mm]					PRICE EUR	kg	m3	pcs	COMPONENTS
	W <sub>1</sub>	W <sub>2</sub>	D <sub>1</sub>	D <sub>2</sub>	H					
TRA121	2440	848	-	-	1090	1 335,-	109.0	0.394	9	TR4L+2xTR90+TR08+TR4P +2xNL41
TRA122	2640	848	-	-	1090	1 355,-	116.0	0.406	9	TR4L+2xTR90+TR10+TR4P +2xNL41
TRA123	2840	848	-	-	1090	1 370,-	120.0	0.418	9	TR4L+2xTR90+TR12+TR4P +2xNL41
TRA124	3040	848	-	-	1090	1 385,-	122.0	0.430	9	TR4L+2xTR90+TR14+TR4P +2xNL41

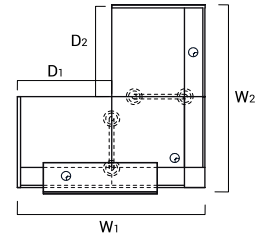
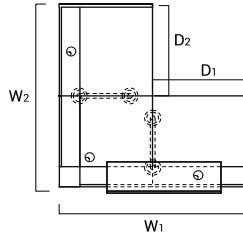
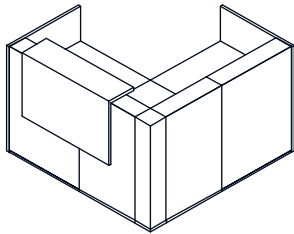

INDEX SYMBOL	DIMENSIONS [mm]					PRICE EUR	kg	m3	pcs	COMPONENTS
	W <sub>1</sub>	W <sub>2</sub>	D <sub>1</sub>	D <sub>2</sub>	H					
TRA25	1648	1705	-	-	1159	1 755,-	141.0	0.586	9	TR1L+TR08+TR90+TR08+TR1P +TR99+2xNL41
TRA26	1848	1705	-	-	1159	1 775,-	148.0	0.598	9	TR1L+TR08+TR90+TR10+TR1P +TR99+2xNL41
TRA27	2048	1705	-	-	1159	1 790,-	152.0	0.611	9	TR1L+TR08+TR90+TR12+TR1P +TR99+2xNL41
TRA28	2248	1705	-	-	1159	1 805,-	154.0	0.623	9	TR1L+TR08+TR90+TR14+TR1P +TR99+2xNL41

DESCRIPTION

- NET WEIGHT

VOLUME

NUMBER OF PACKAGES

RECEPTION DESKS SYSTEMS

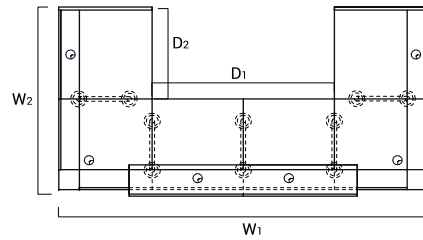
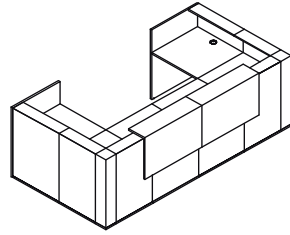

INDEX SYMBOL	DIMENSIONS [mm]					PRICE EUR	kg	m3	pcs	COMPONENTS
	W <sub>1</sub>	W <sub>2</sub>	D <sub>1</sub>	D <sub>2</sub>	H					
TRA29	3240	1705	-	-	1159	3 370,-	250.0	1.166	17	TR1L+2xTR08+2xTR90+2xTR08 +TR1P+2xTR99+5xNL41
TRA30	3640	1705	-	-	1159	3 410,-	264.0	1.190	17	TR1L+2xTR08+2xTR90+2xTR10 +TR1P+2xTR99+5xNL41
TRA31	4040	1705	-	-	1159	3 440,-	272.0	1.214	17	TR1L+2xTR08+2xTR90+2xTR12 +TR1P+2xTR99+5xNL41
TRA32	4440	1705	-	-	1159	3 470,-	276.0	1.239	17	TR1L+2xTR08+2xTR90+2xTR14 +TR1P+2xTR99+5xNL41

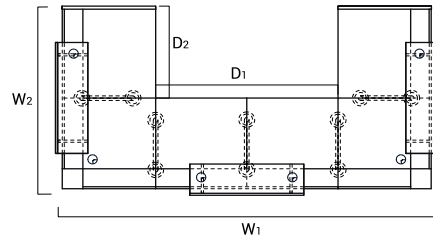
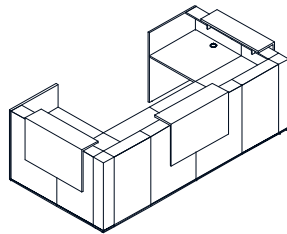

INDEX SYMBOL	DIMENSIONS [mm]					PRICE EUR	kg	m3	pcs	COMPONENTS
	W <sub>1</sub>	W <sub>2</sub>	D <sub>1</sub>	D <sub>2</sub>	H					
TRA129	3354	1705	-	-	1159	3 930,-	267.0	1.349	18	TR1L+2xTR08+2xTR90+2xTR08 +TR1P+3xTR99+5xNL41
TRA130	3754	1705	-	-	1159	3 970,-	281.0	1.374	18	TR1L+2xTR08+2xTR90+2xTR10 +TR1P+3xTR99+5xNL41
TRA131	4154	1705	-	-	1159	4 000,-	289.0	1.398	18	TR1L+2xTR08+2xTR90+2xTR12 +TR1P+3xTR99+5xNL41
TRA132	4554	1705	-	-	1159	4 030,-	293.0	1.422	18	TR1L+2xTR08+2xTR90+2xTR14 +TR1P+3xTR99+5xNL41

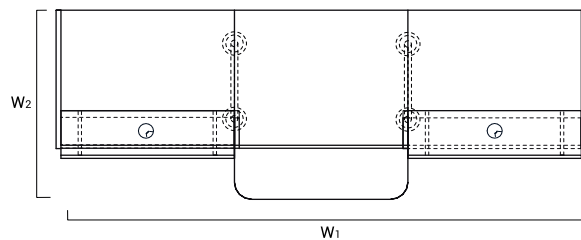
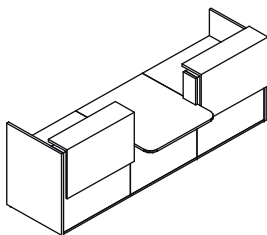

INDEX SYMBOL	DIMENSIONS [mm]					PRICE EUR	kg	m3	pcs	COMPONENTS
	W <sub>1</sub>	W <sub>2</sub>	D <sub>1</sub>	D <sub>2</sub>	H					
TRA33	3056	1120	-	-	1159	2 165,-	169.0	0.793	11	TR1L+TR10+TR2P+TR11+TR2L +TR10+TR1P+2xTR99+2xNL41
TRA34	3456	1120	-	-	1159	2 195,-	177.0	0.817	11	TR1L+TR12+TR2P+TR11+TR2L +TR12+TR1P+2xTR99+2xNL41
TRA35	3856	1120	-	-	1159	2 225,-	181.0	0.841	11	TR1L+TR14+TR2P+TR11+TR2L +TR14+TR1P+2xTR99+2xNL41

DESCRIPTION

- NET WEIGHT

VOLUME

NUMBER OF PACKAGES

RECEPTION DESKS SYSTEMS

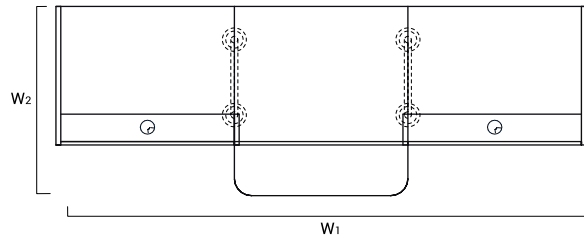
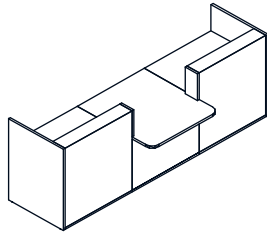

INDEX SYMBOL	DIMENSIONS [mm]					PRICE EUR				COMPONENTS
	W <sub>1</sub>	W <sub>2</sub>	D <sub>1</sub>	D <sub>2</sub>	H		kg	m <sup>3</sup>	pcs	
<b>TRA133</b>	3056	1120	-	-	1090	1 045,-	135.0	0.426	9	TR12+TR10+TR2P+TR11+TR2L +TR10+TR1P+2xNL41
<b>TRA134</b>	3456	1120	-	-	1090	1 075,-	143.0	0.451	9	TR12+TR12+TR2P+TR11+TR2L +TR12+TR1P+2xNL41
<b>TRA135</b>	3856	1120	-	-	1090	1 105,-	147.0	0.475	9	TR12+TR14+TR2P+TR11+TR2L +TR14+TR1P+2xNL41

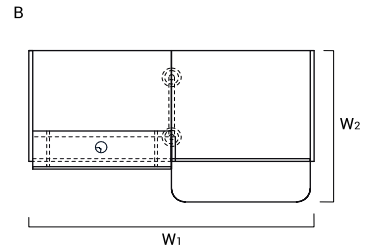
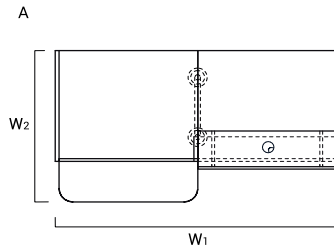
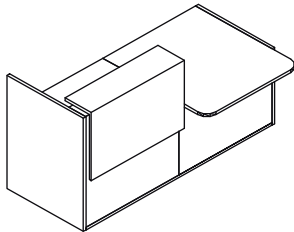

INDEX SYMBOL	DIMENSIONS [mm]					PRICE EUR				COMPONENTS
	W <sub>1</sub>	W <sub>2</sub>	D <sub>1</sub>	D <sub>2</sub>	H		kg	m <sup>3</sup>	pcs	
A <b>TRA36L</b>	2056	1120	-	-	1159	1 275,-	111.5	0.467	7	TR1L+TR10+TR2P+TR11+TR3P +TR99+NL41
B <b>TRA36P</b>	2056	1120	-	-	1159	1 275,-	111.5	0.467	7	TR3L+TR11+TR2L+TR10+TR1P +TR99+NL41
A <b>TRA37L</b>	2256	1120	-	-	1159	1 290,-	115.5	0.479	7	TR1L+TR12+TR2P+TR11+TR3P +TR99+NL41
B <b>TRA37P</b>	2256	1120	-	-	1159	1 290,-	115.5	0.479	7	TR3L+TR11+TR2L+TR12+TR1P +TR99+NL41
A <b>TRA38L</b>	2456	1120	-	-	1159	1 305,-	117.5	0.491	7	TR1L+TR14+TR2P+TR11+TR3P +TR99+NL41
B <b>TRA38P</b>	2456	1120	-	-	1159	1 305,-	117.5	0.492	7	TR3L+TR11+TR2L+TR14+TR1P +TR99+NL41

DESCRIPTION

- NET WEIGHT

VOLUME

NUMBER OF PACKAGES

RECEPTION DESKS SYSTEMS

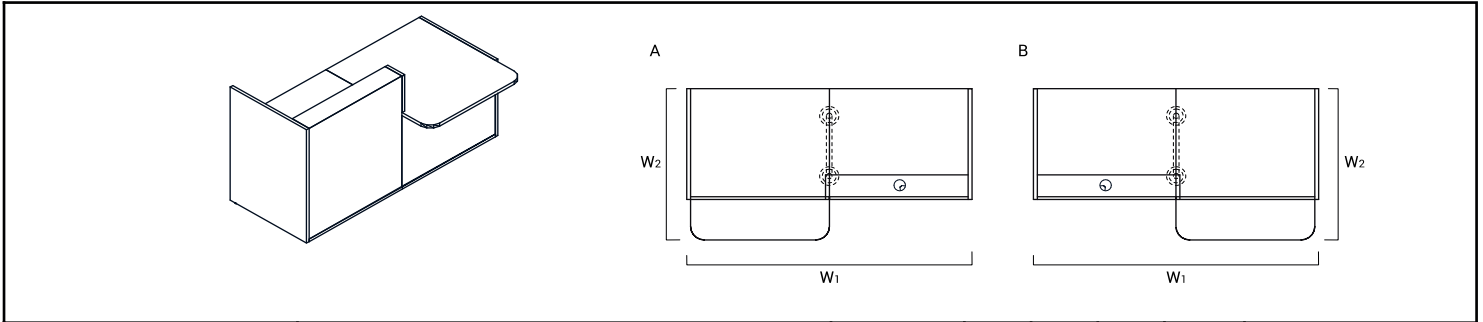

INDEX SYMBOL	DIMENSIONS [mm]					PRICE EUR				COMPONENTS
	W <sub>1</sub>	W <sub>2</sub>	D <sub>1</sub>	D <sub>2</sub>	H		kg	m <sup>3</sup>	pcs	
A <b>TRA136L</b>	2056	1120	-	-	1090	715,-	94.5	0.283	6	TR1L+TR10+TR2P+TR11+TR3P+NL41
B <b>TRA136P</b>	2056	1120	-	-	1090	715,-	94.5	0.284	6	TR3L+TR11+TR2L+TR10+TR1P+NL41
A <b>TRA137L</b>	2256	1120	-	-	1090	730,-	98.5	0.295	6	TR1L+TR12+TR2P+TR11+TR3P+NL41
B <b>TRA137P</b>	2256	1120	-	-	1090	730,-	98.5	0.296	6	TR3L+TR11+TR2L+TR12+TR1P+NL41
A <b>TRA138L</b>	2456	1120	-	-	1090	745,-	100.5	0.308	6	TR1L+TR14+TR2P+TR11+TR3P+NL41
B <b>TRA138P</b>	2456	1120	-	-	1090	745,-	100.5	0.308	6	TR3L+TR11+TR2L+TR14+TR1P+NL41

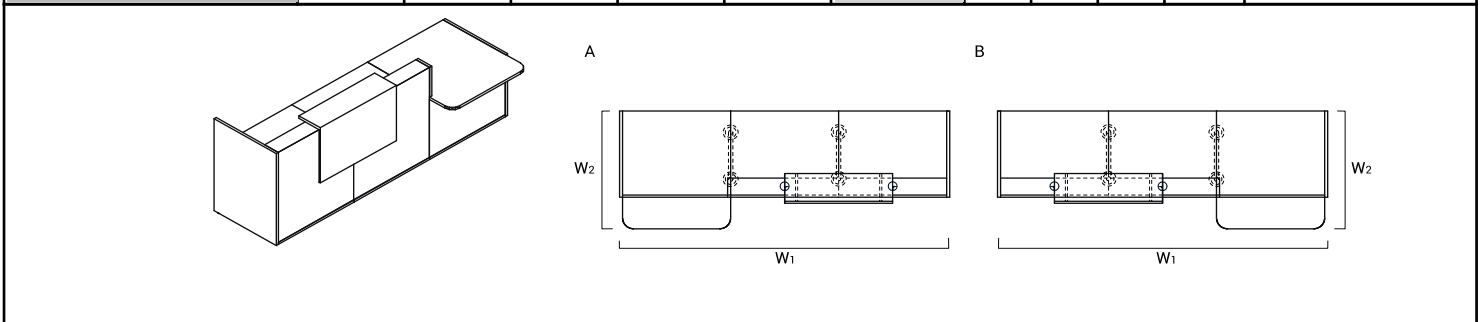



INDEX SYMBOL	DIMENSIONS [mm]					PRICE EUR				COMPONENTS
	W <sub>1</sub>	W <sub>2</sub>	D <sub>1</sub>	D <sub>2</sub>	H		kg	m <sup>3</sup>	pcs	
A <b>TRA39L</b>	3056	1120	-	-	1159	1 570,-	145.5	0.596	9	TR1L+2xTR10+TR2P+TR11+TR3P+TR99+2xNL41
B <b>TRA39P</b>	3056	1120	-	-	1159	1 570,-	145.5	0.597	9	TR3L+TR11+TR2L+2xTR10+TR1P+TR99+2xNL41
A <b>TRA40L</b>	3456	1120	-	-	1159	1 600,-	153.5	0.620	9	TR1L+2xTR12+TR2P+TR11+TR3P+TR99+2xNL41
B <b>TRA40P</b>	3456	1120	-	-	1159	1 600,-	153.5	0.621	9	TR3L+TR11+TR2L+2xTR12+TR1P+TR99+2xNL41
A <b>TRA41L</b>	3856	1120	-	-	1159	1 630,-	157.5	0.645	9	TR1L+2xTR14+TR2P+TR11+TR3P+TR99+2xNL41
B <b>TRA41P</b>	3856	1120	-	-	1159	1 630,-	157.5	0.645	9	TR3L+TR11+TR2L+2xTR14+TR1P+TR99+2xNL41

DESCRIPTION







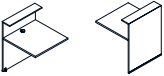

- NET WEIGHT

VOLUME

NUMBER OF PACKAGES

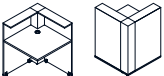
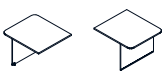
PRODUCT ILLUSTRATION	DIMENSIONS [mm]			INDEX SYMBOL	PRICE EUR					COMMENTS
	WIDTH	DEPTH	HEIGHT			kg	m3	pcs		

COMPOSITION ELEMENTS

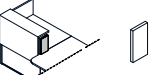
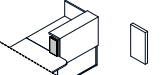

	800	818	1090	TR08	245,-	25.0	0.054	1		
	1000	818	1090	TR10	265,-	32.0	0.067	1		
	1200	818	1090	TR12	280,-	36.0	0.079	1		
	1400	818	1090	TR14	295,-	38.0	0.091	1		
	818	818	1090	TR90	475,-	36.0	0.098	2		
	1000	1120	740	TR11	245,-	30.0	0.092	1		
	1000	282	650	TR99	560,-	17.0	0.183	1		decorative lighted element
	28	820	1090	TR1L	85,-	17.0	0.035	1		side panel for high units -left
	28	820	1090	TR1P	85,-	17.0	0.035	1		side panel for high units -right
	28	182	350	TR2L	20,-	1.5	0.003	1		left upper side panel for combining low and high element
	28	182	350	TR2P	20,-	1.5	0.003	1		right upper side panel for combining low and high element

DESCRIPTION



 - NET WEIGHT

 VOLUME

 NUMBER OF PACKAGES

PRODUCT ILLUSTRATION	DIMENSIONS [mm]			INDEX SYMBOL	PRICE EUR				COMMENTS
	WIDTH	DEPTH	HEIGHT			kg	m3	pcs	

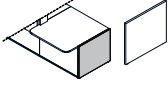
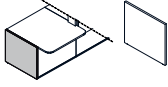
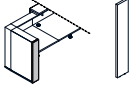
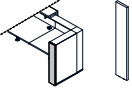
**COMPOSITION ELEMENTS**

	28	820	740	<b>TR3L</b>	70,-	12.0	0.025	1	left side panel for low unit
	28	820	740	<b>TR3P</b>	70,-	12.0	0.025	1	right side panel for low unit
	28	182	1090	<b>TR4L</b>	40,-	4.0	0.008	1	side panel for high units -left
	28	182	1090	<b>TR4P</b>	40,-	4.0	0.008	1	side panel for high units - right
	585	142	712	<b>NL41</b>	30,-	2.0	0.063	1	round profile leg

DESCRIPTION

 - NET WEIGHT

 VOLUME

 NUMBER OF PACKAGES



